

BH

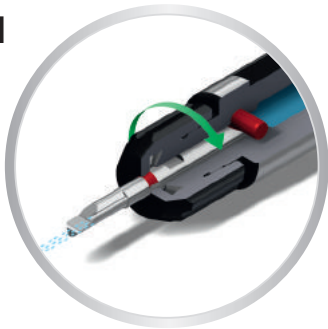

BHS

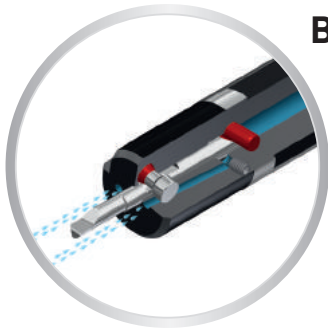

BHY

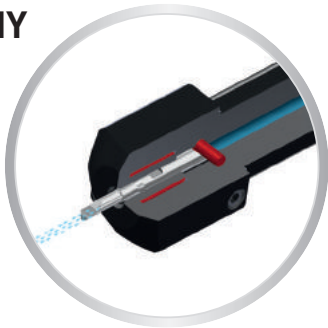

BHK

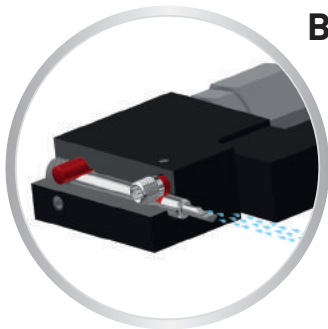

Système de désignation
Bezeichnungssystem
Designation system **Info** > **10.02**

Nuances & paramètres de coupe
Sorten & Schnittwerte
Grades & machining data > **10.08**

Porte-outils
Halter
Holders **BH / BHS / BHY / BHK** > **10.10**

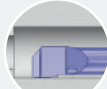
Alésage
Ausbohren
Boring **BA / BAX**  > **10.20**

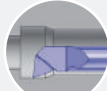

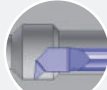
Alésage-copiage
Ausbohren-kopieren
Boring chambering **BCX**  > **10.24**

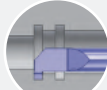
Copiage
Kopieren
Chambering **C45 / C45X**  > **10.26**

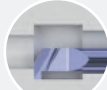
Gorge
Einstechen
Grooving **GX**  > **10.30**

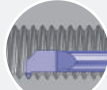
Fonçage-tournage
Einstechen und drehen
Grooving and turning **GTX**  > **10.32**

Filetage
Gewindedrehen
Threading **TP60° / TP55° / TM**  > **10.34**

Gorge frontale
Axiales Stechen
Axial grooving **FEG / FIG**   > **10.40**

Ébauches / Jauges d'alignement / Adaptations machines / Accessoires
Rohlinge / Richtplatten / Maschinenanpassungen / Zubehöre
Blanks / Adjusting tools / Machines adapters / Accessories > **10.42**

Système de désignation des porte-outils

Halter Bezeichnungssystem

Holders designation system

BHK

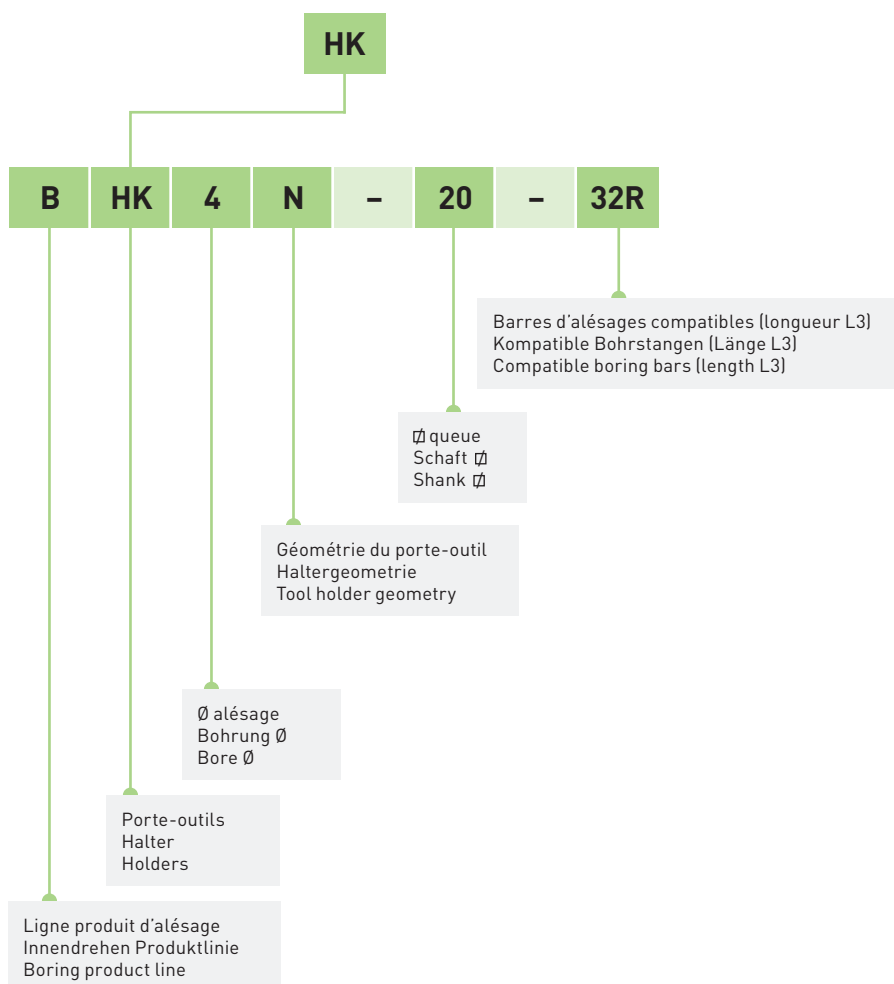
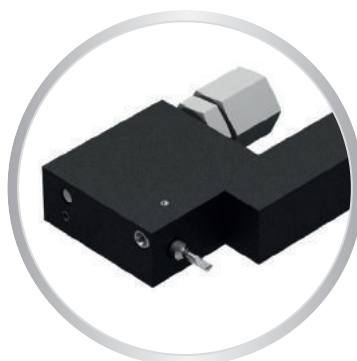

Système de désignation des barres d'alésage

Bohrstangen Bezeichnungssystem

Boring bars designation system

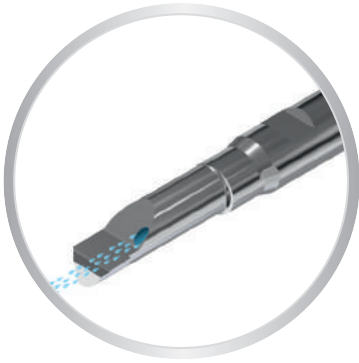

B

F

B B 4 R - 25 - 75 - BAX - R05 - ZN

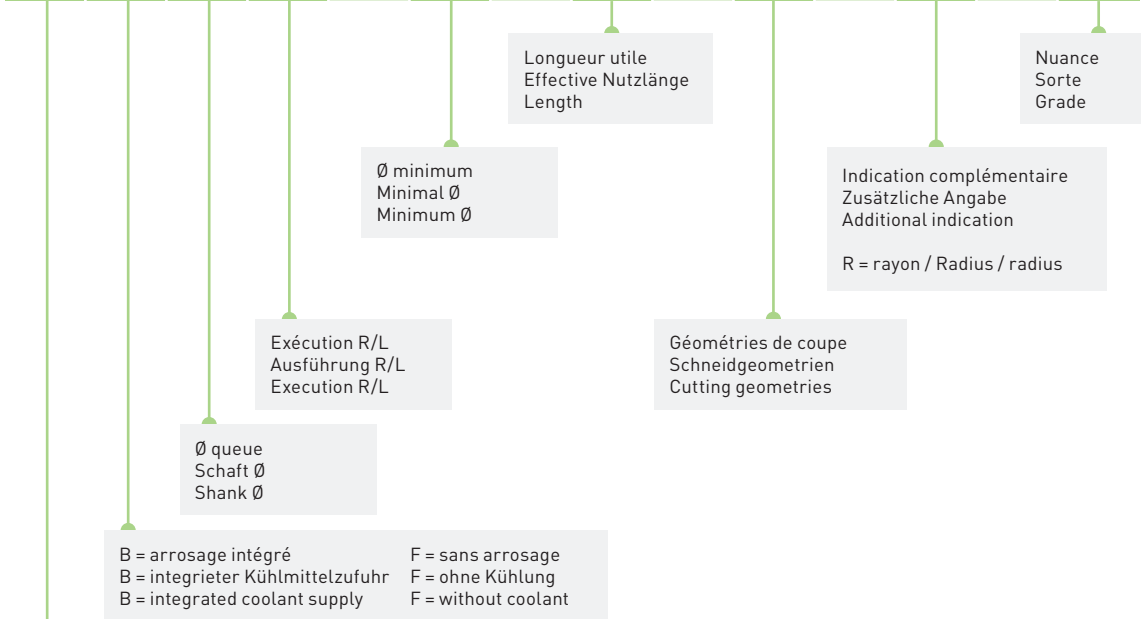

Porte-outils avec écrou de serrage

Halter mit Spannmutter

Tool holders with clamping nut

BH-D

Arrosage par la barre d'alésage

Kühlung durch die Bohrstange

Cooling through the boring bar

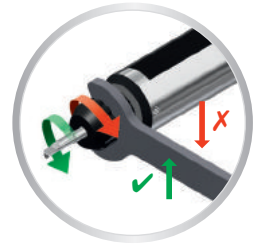
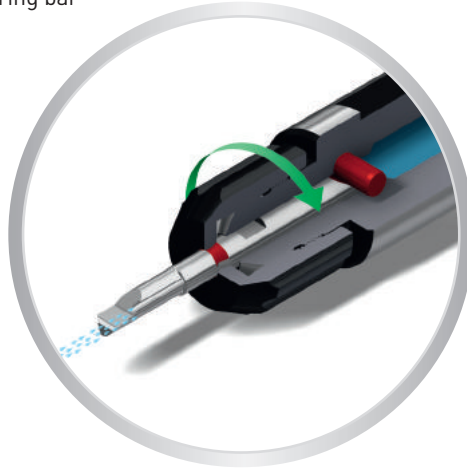

Porte-outils avec arrosage multiple

Halter mit mehrfaches Kühlungssystem

Tool holders with multiple coolant system

BHS-D

Système de serrage à vis transversale

Querverschraubungssystem

Clamping system with transverse screw

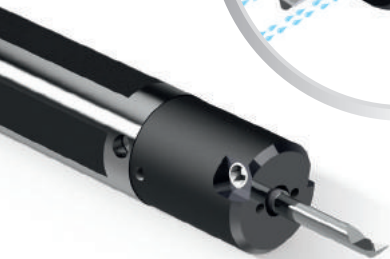
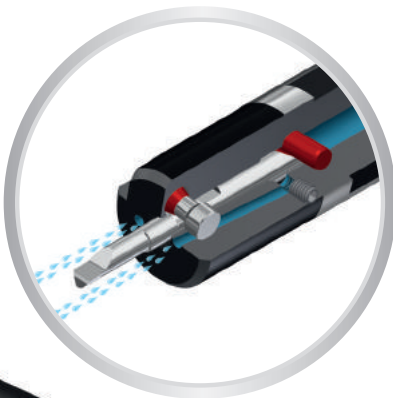

Arrosage sur l'arête de coupe

Kühlung auf der Schneidkante

Cooling on the cutting edge

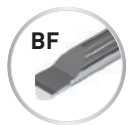
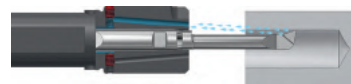

Arrosage favorisant l'évacuation des copeaux

Spanabfuhr fördernde Kühlung

Cooling for better chip outflow

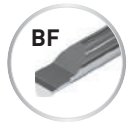
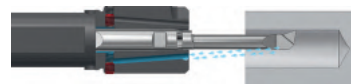

Arrosage par le centre de l'outil

Zentrale Kühlmittelzufuhr

Cooling through the center of the tool

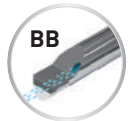

IN-LINE

- Porte-outils à serrage hydraulique
- Halter mit Hydro-Dehnspann-System
- Tool holders with hydraulic clamping system

BHY



Excellente absorption des vibrations!
Ausgezeichnete Schwingungsdämpfung!
Excellent vibration absorbtion!

Arrosage par la barre d'alésage
Kühlung durch die Bohrstange
Cooling through the boring bar

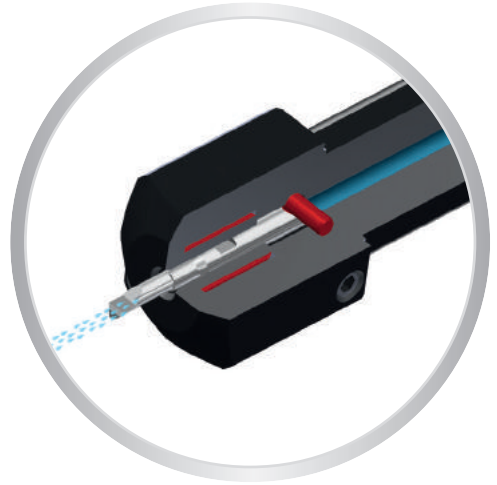

- Porte-outils coudés
- Gekröpfte Halter
- Cranked tool holders

BHK

Système de serrage à vis transversale
Querverschraubungssystem
Clamping system with transverse screw

Arrosage par la barre d'alésage
Kühlung durch die Bohrstange
Cooling through the boring bar

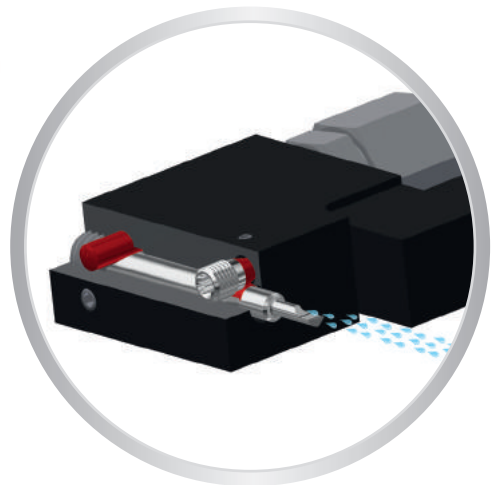
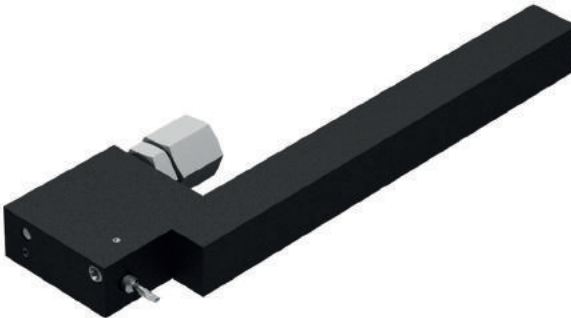

Accessoires de serrage

Spannzubehöre

Clamping accessories

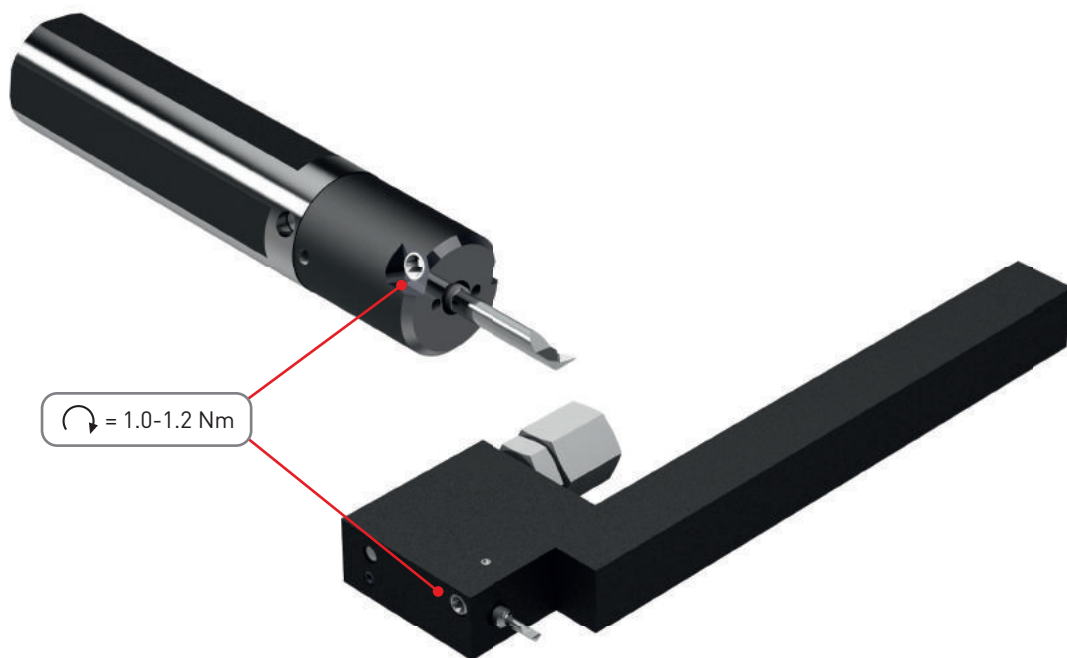

Nous recommandons le serrage des porte-outils types BHS et BHK avec ce type de tournevis dynamométrique.

Wir empfehlen für das Anziehen der Halter Typ BHS und BHK diese Art von Drehmomentschraubendreher.

For holders type BHS and BHK clamping, we recommend this kind of torque screwdriver.



Art. N°

SET-NM1.2-TX8

Nuances

Sorten

Grades

P

M

N

S

ZTAF

ZN + revêtement PVD
ZN + PVD Beschichtung
ZN + PVD coating

- nuance universelle pour l'usinage des aciers, aciers inoxydables, aciers alliés, alliage de titane
- bonne résistance à la température

- Universalsorte für die Bearbeitung von Stahl, rostfreiem Stahl, Stahllegierung, Titanlegierung
- gute Warmfestigkeit

- universal grade for steel, stainless steel, alloyed steel, titanium alloys
- good heat resistance

P

M

S

ZTAXF

ZN + revêtement PVD
ZN + PVD Beschichtung
ZN + PVD coating

- nuance très résistante à l'usure et à la température, recommandée pour l'usinage des matières suivantes: Inox 304, 316L, 317L, 904, Phynox
- aciers alliés contenant: Chrome Nickel, Vanadium, Molybdène, ...

- sehr verschleissfeste und temperaturbeständige Sorte. Für folgende Materialien empfohlen: Inox 304, 316L, 317L, 904, Phynox
- legierter Stahl enthaltend: Chrom-Nickel, Vanadium, Molybdän, ...

- very wear and high temperature resistant grade. Recommended for following material: Inox 304, 316L, 317L, 904, Phynox
- alloy steel containing: Chrome-nickel, Vanadium, Molybdenum, ...

P

N

S

ZN

non revêtu
unbeschichtet
uncoated

- nuance de base micro-grain tenace
- 1^{er} choix pour l'usinage des métaux non ferreux

- zähe Basis Feinkornsorte
- beste Wahl für die Bearbeitung von Nichteisenmetalle

- tough base micro-grain grade
- first choice for non-ferrous materials

Paramètres de coupe

Schnittwerte

Machining data

Matière Werkstoff Material	VC (m/min)	Ø barre d'alésage Bohrstange Ø boring bar Ø		
		Ø1.0 - Ø2.0 (mm/U)	Ø2.5 - Ø4.0 (mm/U)	Ø4.5 - Ø5.5 (mm/U)
Acier de décolletage Automatenstahl Free-cutting steel (P)	60-100	0.02-0.03	0.02-0.08	0.03-0.10
Acier faiblement allié Leicht legierter Stahl Low alloyed steel (P)	50-80	0.01-0.03	0.02-0.05	0.03-0.06
Acier fortement allié Legierter Stahl High alloyed steel (P)	40-60	0.01-0.02	0.02-0.04	0.02-0.06
Acier inoxydable Rostfreistahl Stainless steel (M)	40-90	0.01-0.03	0.02-0.05	0.03-0.08
Aluminium (N)	60-150	0.01-0.03	0.02-0.06	0.03-0.10
Cuivre, laiton, bronze Kupfer, Messing, Bronze Copper, brass, bronze (N)	60-150	0.01-0.03	0.02-0.05	0.03-0.08
Titane Titan Titanium (S)	30-70	0.01-0.03	0.02-0.05	0.03-0.10

Porte-outils avec écrou de serrage

Halter mit Spannmutter

Tool holders with clamping nut



BH4-D

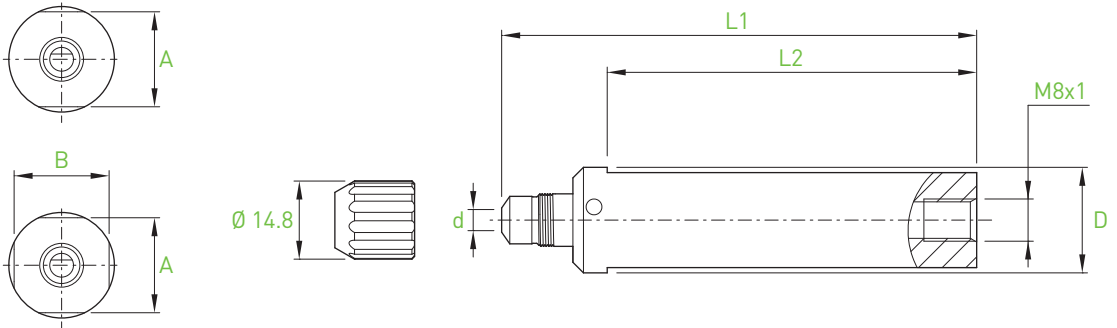

> page 10.05



d	Bars	D	L1	L2	A x B	2 flats	4 flats	Art. N°
4	BB4... BF4...	10	75	55	8.8x8.8	■		BH4-D10-75
		12	75	55	11.2x11.2	■		BH4-D12-75
		12.7	75	55	11.2x11.2	■		BH4-D12.7-75
		15.87	75	55	14x14	■		BH4-D15.87-75
		16	75	55	14x14	■		BH4-D16-75
		16	75	55	14x14		■	BH4-D16-75-F4
		19.05	90	70	17x17	■		BH4-D19.05-90
		20	90	70	18x18	■		BH4-D20-90
		20	90	70	18x18		■	BH4-D20-90-F4
		20	160	140	18x18		■	BH4-D20-160-F4
		22	90	70	20x20	■		BH4-D22-90
		22	90	70	20x20		■	BH4-D22-90-F4
		22	130	110	20x20		■	BH4-D22-130-F4
		25	100	80	23x23	■		BH4-D25-100
		25	100	80	23x23		■	BH4-D25-100-F4
		25	170	150	23x23		■	BH4-D25-170-F4
25.4	100	80	23.4x23.4	■		BH4-D25.4-100		
28	100	80	26x26	■		BH4-D28-100		

Pièces de rechange Ersatzteile Spare parts	 Art. N°	 Art. N°
BH4...	BH4-M10	C-BH4-M10

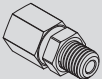
Option	 Art. N°
BH4...	J-M8X1-D6

more option
see JET-Line

Porte-outils avec écrou de serrage

Halter mit Spannmutter

Tool holders with clamping nut

BH6-D



> page 10.05

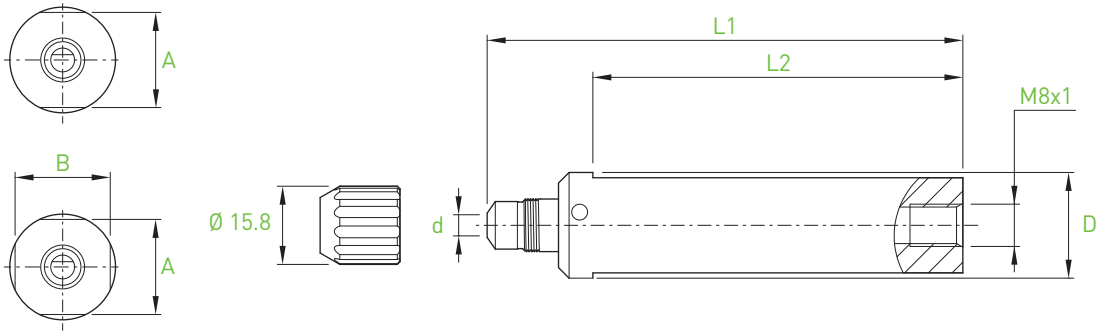

d	Bars	D	L1	L2	A x B	2 flats	4 flats	Art. N°
6	BB6... BF6...	12	75	55	11.2x11.2	■		BH6-D12-75
		12.7	75	55	11.2x11.2	■		BH6-D12.7-75
		15.87	75	55	14x14	■		BH6-D15.87-75
		16	75	55	14x14	■		BH6-D16-75
		19.05	90	70	17x17	■		BH6-D19.05-90
		20	90	70	18x18	■		BH6-D20-90
		20	90	70	18x18		■	BH6-D20-90-F4
		20	160	140	18x18		■	BH6-D20-160-F4
		22	90	70	20x20	■		BH6-D22-90
		22	90	70	20x20		■	BH6-D22-90-F4
		22	130	110	20x20		■	BH6-D22-130-F4
		25	100	80	23x23	■		BH6-D25-100
		25	100	80	23x23		■	BH6-D25-100-F4
		25	170	150	23x23		■	BH6-D25-170-F4
		25.4	100	80	23.4x23.4	■		BH6-D25.4-100
28	100	80	26x26	■		BH6-D28-100		

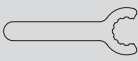
Pièces de rechange Ersatzteile Spare parts	 Art. N°	 Art. N°
BH6...	BH6-M12	C-BH6-M12

Option	 Art. N°
BH6...	J-M8X1-D6 <small>more option see JET-Line</small>

■ = disponible / verfügbar / available
□ = selon disponibilité du stock / jenach Lagerverfügbarkeit / depending the stock availability

Porte-outils avec arrosage multiple
 Halter mit mehrfaches Kühlungssystem
 Tool holders with multiple coolant system

BHS4-D

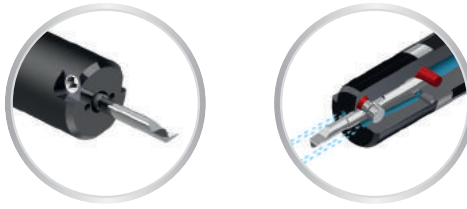

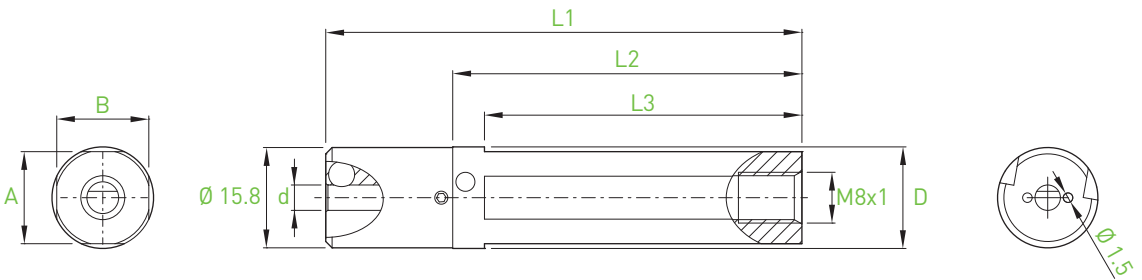

> page 10.05/10.07

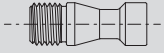
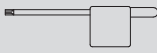

d	Bars	D	L1	L2	L3	A x B	Art. N°
4	BB4... BF4...	10	75	55	50	9.2x9.2	BHS4-D10-75-F4
		12	75	55	50	11x11	BHS4-D12-75-F4
		12.7	75	55	50	11.7x11.7	BHS4-D12.7-75-F4
		15.87	75	55	50	14.5x14.5	BHS4-D15.87-75-F4
		16	75	55	50	14.5x14.5	BHS4-D16-75-F4
		16	110	90	85	14.5x14.5	BHS4-D16-110-F4
		19.05	90	70	65	17x17	BHS4-D19.05-90-F4
		20	90	70	65	18x18	BHS4-D20-90-F4
		20	160	140	135	18x18	BHS4-D20-160-F4
		22	90	70	65	20x20	BHS4-D22-90-F4
		22	130	110	105	20x20	BHS4-D22-130-F4
		25	100	80	75	23x23	BHS4-D25-100-F4
		25	170	150	145	23x23	BHS4-D25-170-F4
		25.4	100	80	75	23x23	BHS4-D25.4-100-F4
28	100	80	75	26x26	BHS4-D28-100-F4		

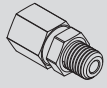
Pièces de rechange Ersatzteile Spare parts	 Art. N°	 Art. N°
BHS4...	V-BHS-M4X0.5-T8	C-T8

Option	 Art. N°	 Art. N°
BHS4...	J-M8X1-D6 <small>more option see JET-Line</small>	SET-NM1.2-TX8

Porte-outils avec arrosage multiple
 Halter mit mehrfaches Kühlungssystem
 Tool holders with multiple coolant system

BHS6-D

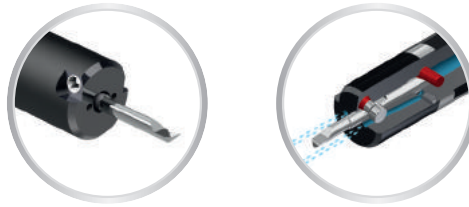

> page 10.05/10.07

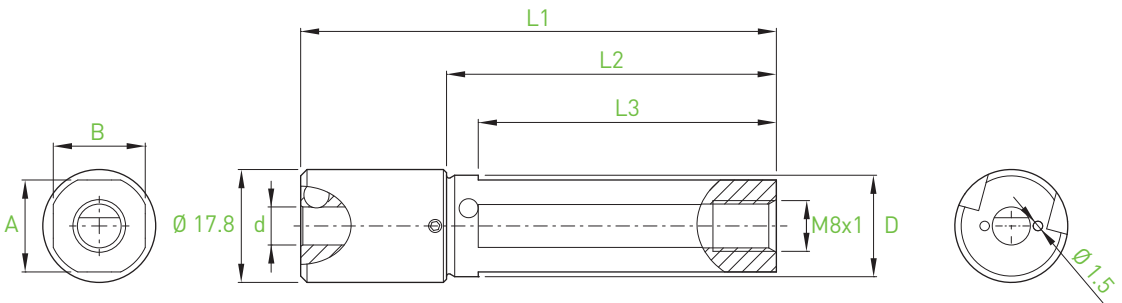

d	Bars	D	L1	L2	L3	A x B	Art. N°
6	BB6... BF6...	12	75	52	47	11x11	BHS6-D12-75-F4
		12.7	75	52	47	11.7x11.7	BHS6-D12.7-75-F4
		15.87	75	52	47	14.5x14.5	BHS6-D15.87-75-F4
		16	75	52	47	14.5x14.5	BHS6-D16-75-F4
		16	110	87	82	14.5x14.5	BHS6-D16-110-F4
		19.05	90	67	62	17x17	BHS6-D19.05-90-F4
		20	90	67	62	18x18	BHS6-D20-90-F4
		20	160	137	132	18x18	BHS6-D20-160-F4
		22	90	67	62	20x20	BHS6-D22-90-F4
		22	130	107	102	20x20	BHS6-D22-130-F4
		25	100	77	72	23x23	BHS6-D25-100-F4
		25	170	147	142	23x23	BHS6-D25-170-F4
		25.4	100	77	72	23x23	BHS6-D25.4-100-F4
28	100	77	72	26x26	BHS6-D28-100-F4		

Pièces de rechange
 Ersatzteile
 Spare parts

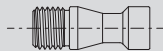

Art. N°

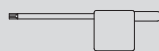

Art. N°

BHS6...

V-BHS-M4X0.5-T8

C-T8

Option

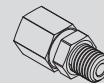

Art. N°



Art. N°

BHS6...

J-M8X1-D6

SET-NM1.2-TX8

more option
 see JET-Line

Porte-outils à serrage hydraulique
 Halter mit Hydro-Dehnspann-System
 Tool holders with hydraulic clamping system

BHY4-D



> page 10.06

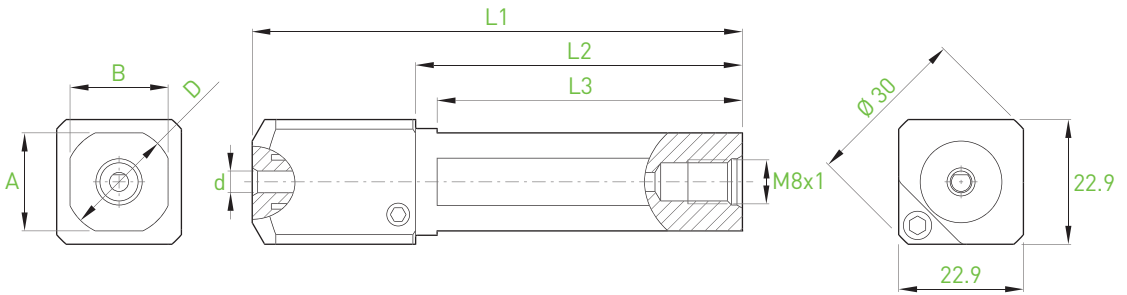

d	Bars	D	L1	L2	L3	A x B	Art. N°
4	BB4... BF4...	12	90	60	55	11.2x11.2	BHY4-D12-90-F4
		16	90	60	55	14.5x14.5	BHY4-D16-90-F4
		19.05	90	60	55	17x17	BHY4-D19.05-90-F4
		20	90	60	55	18x18	BHY4-D20-90-F4
		22	90	60	55	20x20	BHY4-D22-90-F4
		25	100	70	65	23x23	BHY4-D25-100-F4

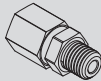
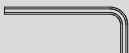
Pièces de rechange Ersatzteile Spare parts	 Art. N°	 Art. N°
BHY4...	J-M8X1-D6 more option see JET-Line	C-6P-3.0

Porte-outils à serrage hydraulique
 Halter mit Hydro-Dehnspann-System
 Tool holders with hydraulic clamping system

BHY6-D

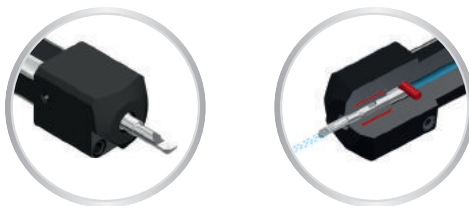

> page 10.06

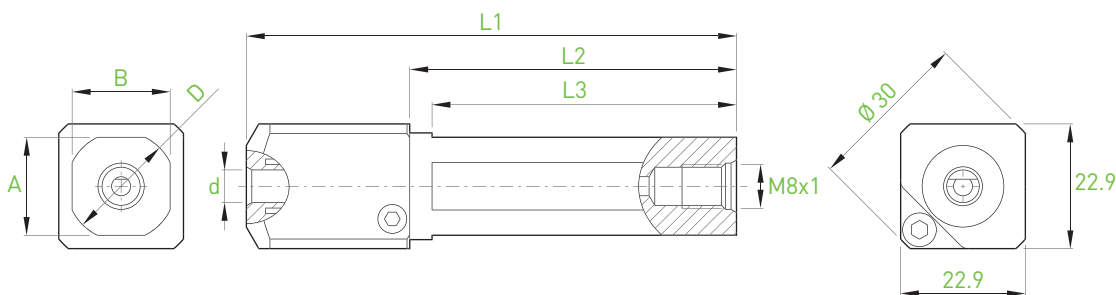

d	Bars	D	L1	L2	L3	A x B	Art. N°
6	BB6... BF6...	12	90	60	55	11.2x11.2	BHY6-D12-90-F4
		16	90	60	55	14.5x14.5	BHY6-D16-90-F4
		19.05	90	60	55	17x17	BHY6-D19.05-90-F4
		20	90	60	55	18x18	BHY6-D20-90-F4
		22	90	60	55	20x20	BHY6-D22-90-F4
		25	100	70	65	23x23	BHY6-D25-100-F4

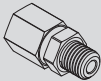
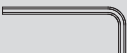
Pièces de rechange Ersatzteile Spare parts		
	Art. N°	Art. N°
BHY6...	J-M8X1-D6 more option see JET-Line	C-6P-3.0

> page 10.07

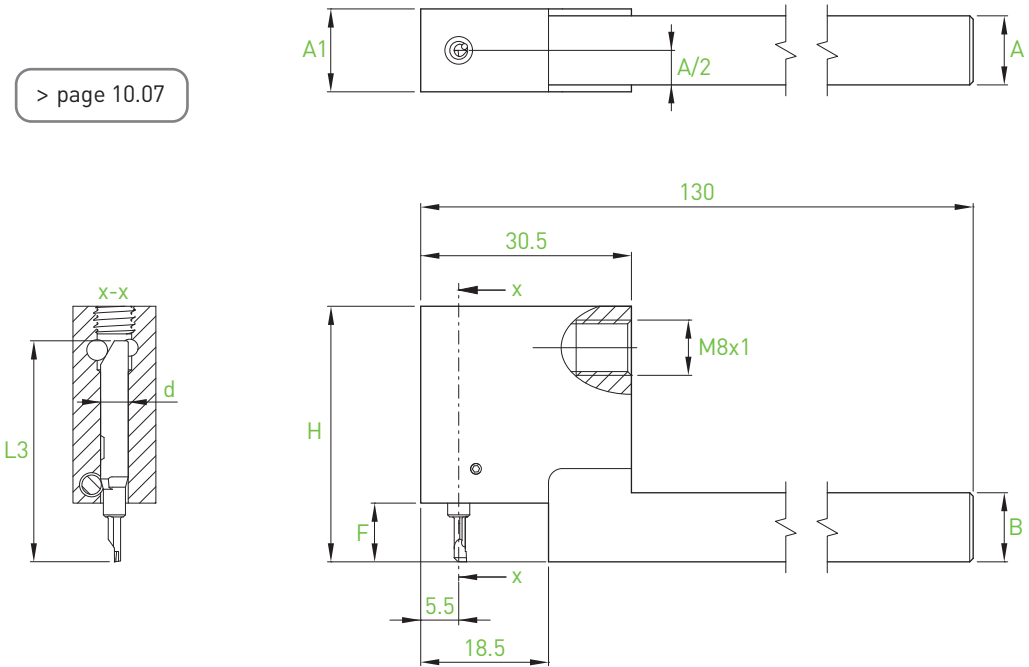

d	Bars	L3	A x B	F	H	A1	Art. N°
4	BB4R... BF4R...	32	8x8	8.5	37	12	BHK4N-0808X-32R
			10x10	8.5	37	12	BHK4N-1010X-32R
			12x12	8.5	37	12	BHK4N-1212X-32R
			16x16	8.5	37	16	BHK4N-1616X-32R
		37	8x8	13.5	42	12	BHK4N-0808X-37R
			10x10	13.5	42	12	BHK4N-1010X-37R
			12x12	13.5	42	12	BHK4N-1212X-37R
			16x16	13.5	42	16	BHK4N-1616X-37R
		42	10x10	18.5	47	12	BHK4N-1010X-42R
			12x12	18.5	47	12	BHK4N-1212X-42R
			16x16	18.5	47	16	BHK4N-1616X-42R

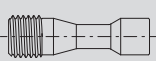
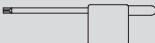
Pièces de rechange Ersatzteile Spare parts	 Art. N°	 Art. N°
BHK4N...	V-BHK-M4X0.5-T8	C-T8

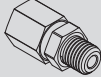
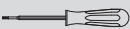
Option	 Art. N°	 Art. N°
BHK4N...	J-M8X1-D6 more option see JET-Line	SET-NM1.2-TX8

Porte-outils coudés
 Kröpfhalter
 Cranked tool holders

BHK6N

> page 10.07

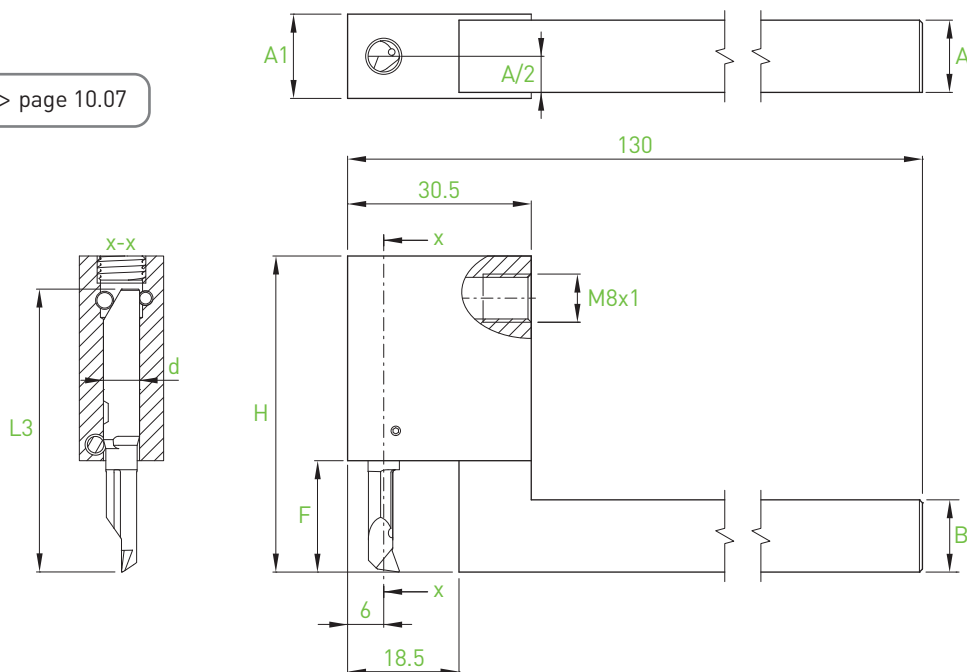

d	Bars	L3	A x B	F	H	A1	Art. N°
6	BB6R... BF6R...	47	10x10	18.5	52.5	12	BHK6N-1010X-47R
			12x12	18.5	52.5	12	BHK6N-1212X-47R
			16x16	18.5	52.5	16	BHK6N-1616X-47R
		57	10x10	28.5	62.5	12	BHK6N-1010X-57R
			12x12	28.5	62.5	12	BHK6N-1212X-57R
			16x16	28.5	62.5	16	BHK6N-1616X-57R

Pièces de rechange Ersatzteile Spare parts	Art. N°	Art. N°
BHK6N...	V-BHK-M4X0.5-T8	C-T8

Option	Art. N°	Art. N°
BHK6N...	J-M8X1-D6 <small>more option see JET-Line</small>	SET-NM1.2-TX8

IN-LINE

Porte-outils section carrée
 Viereckige Halter
 Square holders

BHS4

new

> page 10.07

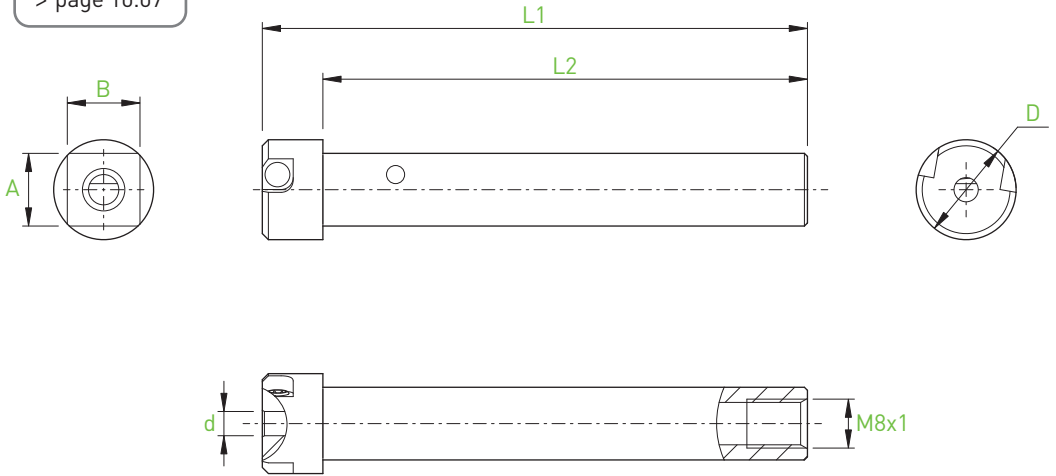

d	Bars	A x B	L1	L2	D	Art. N°
4	BB4... BF4...	12x12	90	80	16.5	BHS4-1212-90
		16x16	100	90	15.5	BHS4-1616-90

Pièces de rechange
 Ersatzteile
 Spare parts

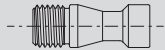

Art. N°

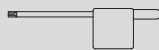

Art. N°

BHS4...

V-BHS-M4X0.5-T8

C-T8

Option

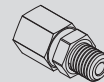

Art. N°



Art. N°

BHS4...

J-M8X1-D6

SET-NM1.2-TX8

more option
 see JET-Line

Porte-outils section carrée

Viereckige Halter

Square holders

BHS6

new

> page 10.05

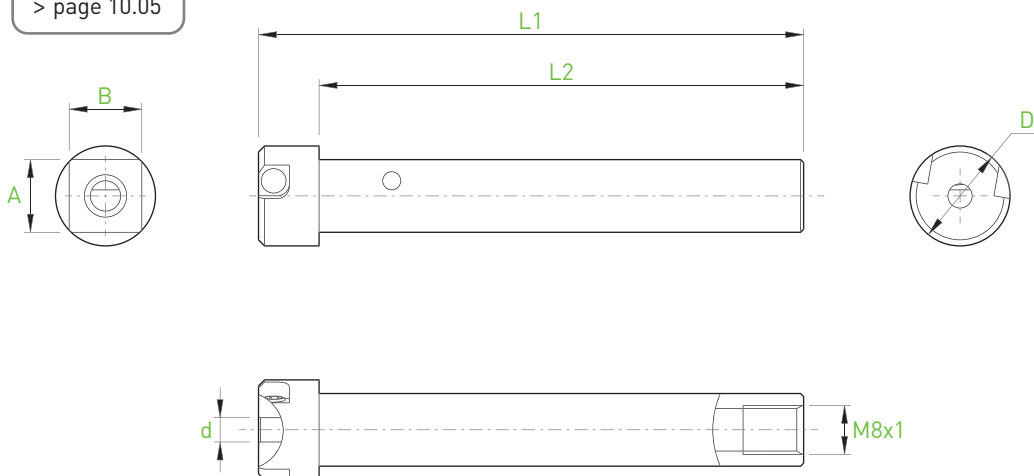

d	Bars	A x B	L1	L2	D	Art. N°
6	BB6... BF6...	12x12 16x16	90 100	80 -	17.5 -	BHS6-1212-90 BHS6-1616-90

Pièces de rechange
Ersatzteile
Spare parts

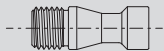

Art. N°

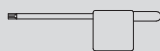

Art. N°

BHS6...

V-BHS-M4X0.5-T8

C-T8

Option

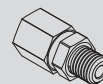

Art. N°



Art. N°

BHS6...

J-M8X1-D6

SET-NM1.2-TX8

more option
see JET-Line

IN-LINE

Alésage
Ausbohren
Boring

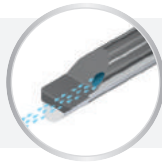

BB4...

BA

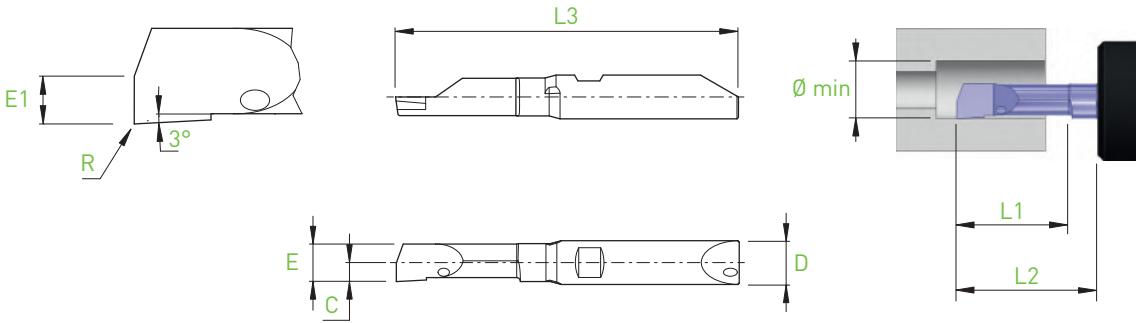

D h5	Holder	Ø min	L1	L2 BH4... BHY4...	L2 BHS4... BHK4...	E	E1	C	R	L3	Art. N°	R			L		
												ZTAF	ZTAXF	ZN	ZTAF	ZTAXF	ZN
4	BH4... BHS4... BHY4... BHK4...	0.3	0.9	10	8.5	0.27	0.13	0.15	0	32	BB4R/L-0309-BA	■	■	■	□	□	□
		0.4	1.2	10	8.5	0.36	0.18	0.20	0	32	BB4R/L-0412-BA	■	■	■	□	□	□
		0.5	1.5	10	8.5	0.45	0.22	0.25	0	32	BB4R/L-0515-BA	■	■	■	□	□	□
		0.6	1.8	10	8.5	0.54	0.27	0.30	0	32	BB4R/L-0618-BA	■	■	■	□	□	new
		0.7	2.1	10	8.5	0.63	0.31	0.35	0	32	BB4R/L-0721-BA	■	■	■	□	□	new
		0.8	2.4	10	8.5	0.72	0.36	0.40	0	32	BB4R/L-0824-BA	■	■	■	□	□	new
		0.9	2.7	10	8.5	0.81	0.40	0.45	0	32	BB4R/L-0927-BA	■	■	■	□	□	new
		1.0	3.0	10	8.5	0.90	0.45	0.60	0.02	32	BB4R/L-1030-BA-R02	■	■	■	□	□	
		1.2	3.6	10	8.5	1.08	0.54	0.60	0.02	32	BB4R/L-1236-BA-R02	■	■	■	□	□	new
		1.5	4.5	10	8.5	1.35	0.67	0.65	0.02	32	BB4R/L-1545-BA-R02	■	■	■	□	□	
		2.0	6.0	10	8.5	1.80	0.90	1.15	0.02	32	BB4R/L-2060-BA-R02	■	■	■	□	□	
		2.5	7.5	10	8.5	2.25	1.13	1.30	0.02	32	BB4R/L-2575-BA-R02	■	■	■	□	□	
		3.0	9.0	15	13.5	2.70	1.35	1.35	0.05	37	BB4R/L-3090-BA-R05	■	■	■	□	□	
3.5	10.5	15	13.5	3.15	1.58	1.60	0.05	37	BB4R/L-35105-BA-R05	■	■	■	□	□			

Alésage
Ausbohren
Boring



BF4...

BA

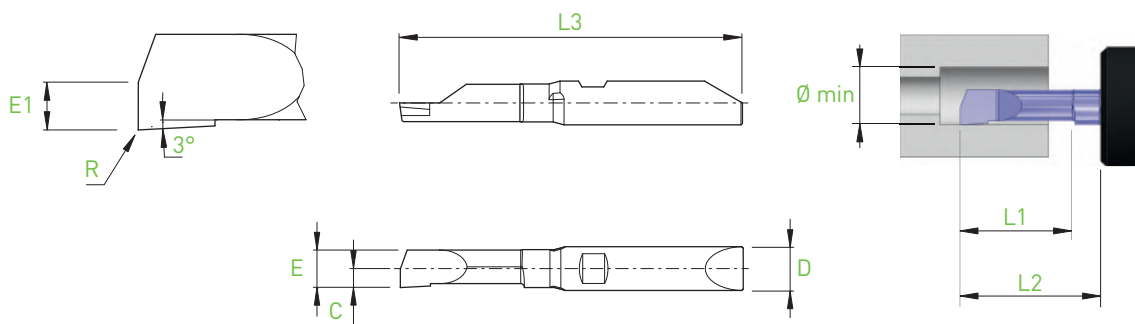

D h5	Holder	Ø min	L1	L2 BH4... BHY4...	L2 BHS4... BHK4...	E	E1	C	R	L3	Art. N°	R			L		
												ZTAF	ZTAXF	ZN	ZTAF	ZTAXF	ZN
4	BH4... BHS4... BHY4... BHK4...	0.3	0.9	10	8.5	0.27	0.13	0.15	0	32	BF4R/L-0309-BA	■	■	■	□	□	□
		0.4	1.2	10	8.5	0.36	0.18	0.20	0	32	BF4R/L-0412-BA	■	■	■	□	□	□
		0.5	1.5	10	8.5	0.45	0.22	0.25	0	32	BF4R/L-0515-BA	■	■	■	□	□	□
		0.6	1.8	10	8.5	0.54	0.27	0.30	0	32	BF4R/L-0618-BA	■	■	■	□	□	new
		0.7	2.1	10	8.5	0.63	0.31	0.35	0	32	BF4R/L-0721-BA	■	■	■	□	□	new
		0.8	2.4	10	8.5	0.72	0.36	0.40	0	32	BF4R/L-0824-BA	■	■	■	□	□	new
		0.9	2.7	10	8.5	0.81	0.40	0.45	0	32	BF4R/L-0927-BA	■	■	■	□	□	new
		1.0	3.0	10	8.5	0.90	0.45	0.60	0.02	32	BF4R/L-1030-BA-R02	■	■	■	□	□	
		1.2	3.6	10	8.5	1.08	0.54	0.60	0.02	32	BF4R/L-1236-BA-R02	■	■	■	□	□	new
		1.5	4.5	10	8.5	1.35	0.67	0.65	0.02	32	BF4R/L-1545-BA-R02	■	■	■	□	□	
		2.0	6.0	10	8.5	1.80	0.90	1.15	0.02	32	BF4R/L-2060-BA-R02	■	■	■	□	□	
		2.5	7.5	10	8.5	2.25	1.13	1.30	0.02	32	BF4R/L-2575-BA-R02	■	■	■	□	□	
		3.0	9.0	15	13.5	2.70	1.35	1.35	0.05	37	BF4R/L-3090-BA-R05	■	■	■	□	□	
3.5	10.5	15	13.5	3.15	1.58	1.60	0.05	37	BF4R/L-35105-BA-R05	■	■	■	□	□			

■ = disponible / verfügbar / available
□ = selon disponibilité du stock / jenach Lagerverfügbarkeit / depending the stock availability

IN-LINE

Alésage
Ausbohren
Boring

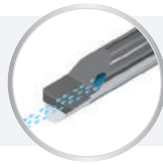

BB4... / BB6...

BAX

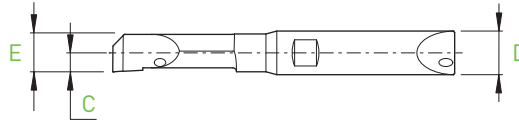
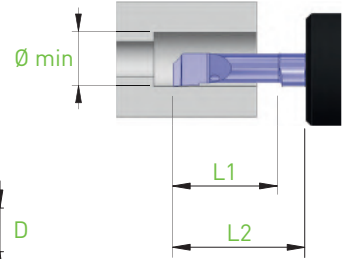
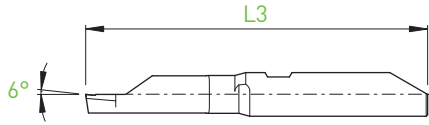
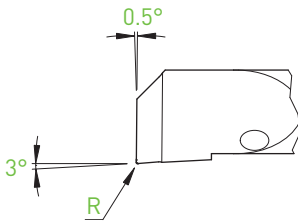

D _{h5}	Holder	Ø min	L1	L2 BH4... BHY4...	L2 BHS4... BHK4...	E	C	R	L3	Art. N°	R			L		
											ZTAF	ZTAXF	ZN	ZTAF	ZN	
4	BH4... BHS4... BHY4... BHK4...	0.5	1.5	10	8.5	0.45	0.25	0	32	BB4R/L-0515-BAX	■	■	■	□	□	
		0.6	1.8	10	8.5	0.54	0.30	0	32	BB4R/L-0618-BAX	■	■	■	□	□	
		0.7	2.1	10	8.5	0.63	0.35	0	32	BB4R/L-0721-BAX	■	■	■	□	□	
		0.8	2.4	10	8.5	0.72	0.40	0	32	BB4R/L-0824-BAX	■	■	■	□	□	
		0.9	2.7	10	8.5	0.81	0.45	0	32	BB4R/L-0927-BAX	■	■	■	□	□	
		1.0	3.0	10	8.5	0.90	0.60	0.02	32	BB4R/L-1030-BAX-R02	■	■	■	□	□	
			5.0	10	8.5	0.90	0.60	0.02	32	BB4R/L-1050-BAX-R02	■	■	■	□	□	
		1.5	4.5	10	8.5	1.35	0.65	0.02	32	BB4R/L-1545-BAX-R02	■	■	■	□	□	
			7.5	10	8.5	1.35	0.65	0.02	32	BB4R/L-1575-BAX-R02	■	■	■	□	□	
		2.0	6.0	10	8.5	1.80	1.15	0.02	32	BB4R/L-2060-BAX-R02	■	■	■	□	□	
			10.0	15	13.5	1.80	1.15	0.02	37	BB4R/L-20100-BAX-R02	■	■	■	□	□	
		2.5	7.5	10	8.5	2.25	1.30	0.05	32	BB4R/L-2575-BAX-R05	■	■	■	□	□	
			12.5	15	13.5	2.25	1.30	0.05	37	BB4R/L-25125-BAX-R05	■	■	■	□	□	
		3.0	9.0	15	13.5	2.70	1.35	0.05	37	BB4R/L-3090-BAX-R05	■	■	■	□	□	
			15.0	20	18.5	2.70	1.35	0.05	42	BB4R/L-30150-BAX-R05	■	■	■	□	□	
		3.5	10.5	15	13.5	3.15	1.60	0.05	37	BB4R/L-35105-BAX-R05	■	■	■	□	□	
17.5	20		18.5	3.15	1.60	0.05	42	BB4R/L-35175-BAX-R05	■	■	■	□	□			
6	BH6... BHS6... BHY6... BHK6...	4.0	12.0	20	18.5	3.80	2.20	0.05	47	BB6R/L-40120-BAX-R05	■	■	■	□	□	
			20.0	30	28.5	3.80	2.20	0.05	57	BB6R/L-40200-BAX-R05	■	■	■	□	□	
		4.5	13.5	20	18.5	4.28	2.30	0.05	47	BB6R/L-45135-BAX-R05	■	■	■	□	□	
			22.5	30	28.5	4.28	2.30	0.05	57	BB6R/L-45225-BAX-R05	■	■	■	□	□	
		5.0	15.0	20	18.5	4.75	2.40	0.05	47	BB6R/L-50150-BAX-R05	■	■	■	□	□	
			25.0	30	28.5	4.75	2.40	0.05	57	BB6R/L-50250-BAX-R05	■	■	■	□	□	
		5.5	16.5	20	18.5	5.15	2.60	0.05	47	BB6R/L-55165-BAX-R05	■	■	■	□	□	
			27.5	30	28.5	5.15	2.60	0.05	57	BB6R/L-55275-BAX-R05	■	■	■	□	□	

Alésage
Ausbohren
Boring



BF4... / BF6...

BAX

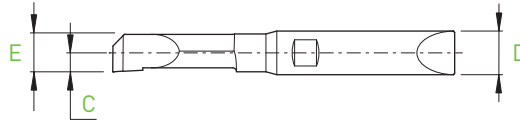
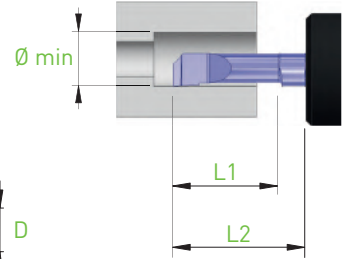
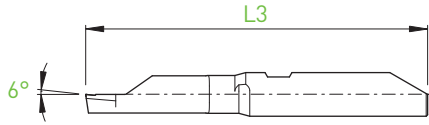
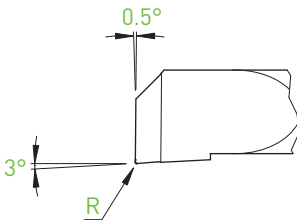

D h5	Holder	Ø min	L1	L2 BH4... BHY4...	L2 BHS4... BHK4...	E	C	R	L3	Art. N°	R			L		
											ZTAF	ZTAXF	ZN	ZTAF	ZN	
4	BH4... BHS4... BHY4... BHK4...	0.5	1.5	10	8.5	0.45	0.25	0	32	BF4R/L-0515-BAX	■	■	■	□	□	
		0.6	1.8	10	8.5	0.54	0.30	0	32	BF4R/L-0618-BAX	■	■	■	□	□	
		0.7	2.1	10	8.5	0.63	0.35	0	32	BF4R/L-0721-BAX	■	■	■	□	□	
		0.8	2.4	10	8.5	0.72	0.40	0	32	BF4R/L-0824-BAX	■	■	■	□	□	
		0.9	2.7	10	8.5	0.81	0.45	0	32	BF4R/L-0927-BAX	■	■	■	□	□	
		1.0	3.0	10	8.5	0.90	0.60	0.02	32	BF4R/L-1030-BAX-R02	■	■	■	□	□	
			5.0	10	8.5	0.90	0.60	0.02	32	BF4R/L-1050-BAX-R02	■	■	■	□	□	
		1.5	4.5	10	8.5	1.35	0.65	0.02	32	BF4R/L-1545-BAX-R02	■	■	■	□	□	
			7.5	10	8.5	1.35	0.65	0.02	32	BF4R/L-1575-BAX-R02	■	■	■	□	□	
		2.0	6.0	10	8.5	1.80	1.15	0.02	32	BF4R/L-2060-BAX-R02	■	■	■	□	□	
			10.0	15	13.5	1.80	1.15	0.02	37	BF4R/L-20100-BAX-R02	■	■	■	□	□	
		2.5	7.5	10	8.5	2.25	1.30	0.05	32	BF4R/L-2575-BAX-R05	■	■	■	□	□	
			12.5	15	13.5	2.25	1.30	0.05	37	BF4R/L-25125-BAX-R05	■	■	■	□	□	
		3.0	9.0	15	13.5	2.70	1.35	0.05	37	BF4R/L-3090-BAX-R05	■	■	■	□	□	
15.0	20		18.5	2.70	1.35	0.05	42	BF4R/L-30150-BAX-R05	■	■	■	□	□			
3.5	10.5	15	13.5	3.15	1.60	0.05	37	BF4R/L-35105-BAX-R05	■	■	■	□	□			
	17.5	20	18.5	3.15	1.60	0.05	42	BF4R/L-35175-BAX-R05	■	■	■	□	□			

D h5	Holder	Ø min	L1	L2 BH6... BHY6...	L2 BHS6... BHK6...	E	C	R	L3	Art. N°	ZTAF	ZTAXF	ZN	ZTAF	ZN
											■	■	■	■	■
6	BH6... BHS6... BHY6... BHK6...	4.0	12.0	20	18.5	3.80	2.20	0.05	47	BF6R/L-40120-BAX-R05	■	■	■	□	□
			20.0	30	28.5	3.80	2.20	0.05	57	BF6R/L-40200-BAX-R05	■	■	■	□	□
		4.5	13.5	20	18.5	4.28	2.30	0.05	47	BF6R/L-45135-BAX-R05	■	■	■	□	□
			22.5	30	28.5	4.28	2.30	0.05	57	BF6R/L-45225-BAX-R05	■	■	■	□	□
		5.0	15.0	20	18.5	4.75	2.40	0.05	47	BF6R/L-50150-BAX-R05	■	■	■	□	□
			25.0	30	28.5	4.75	2.40	0.05	57	BF6R/L-50250-BAX-R05	■	■	■	□	□
		5.5	16.5	20	18.5	5.15	2.60	0.05	47	BF6R/L-55165-BAX-R05	■	■	■	□	□
			27.5	30	28.5	5.15	2.60	0.05	57	BF6R/L-55275-BAX-R05	■	■	■	□	□

■ = disponible / verfügbar / available
□ = selon disponibilité du stock / jenach Lagerverfügbarkeit / depending the stock availability

IN-LINE

- Alésage-copiage
- Ausbohren-kopieren
- Boring chambering

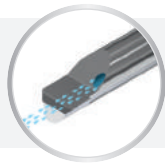

BB4... / BB6...

BCX

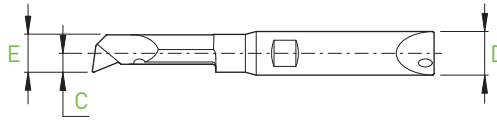
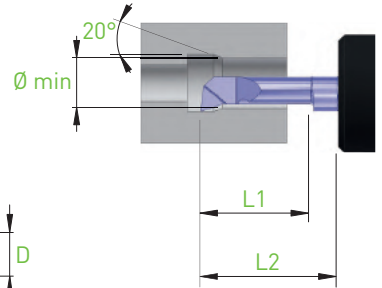
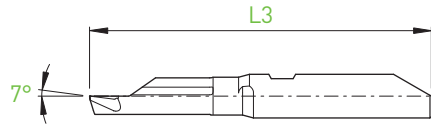
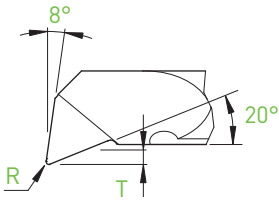

D h5	Holder	Ø min	L1	L2 BH4... BHY4...	L2 BHS4... BHK4...	T	E	C	R	L3	Art. N°	R		L		
												ZTAF	ZTAXF	ZN	ZTAF	ZN
4	BH4... BHS4... BHY4... BHK4...	1.0	3.0	10	8.5	0.15	0.90	0.70	0.05	32	BB4R/L-1030-BCX-R05	■	■	■	□	□
			5.0	10	8.5	0.15	0.90	0.70	0.05	32	BB4R/L-1050-BCX-R05	■	■	■	□	□
		1.5	4.5	10	8.5	0.23	1.35	0.75	0.05	32	BB4R/L-1545-BCX-R05	■	■	■	□	□
			7.5	10	8.5	0.23	1.35	0.75	0.05	32	BB4R/L-1575-BCX-R05	■	■	■	□	□
		2.0	6.0	10	8.5	0.30	1.80	1.15	0.05	32	BB4R/L-2060-BCX-R05	■	■	■	□	□
			10.0	15	13.5	0.30	1.80	1.15	0.05	37	BB4R/L-20100-BCX-R05	■	■	■	□	□
		2.5	7.5	10	8.5	0.38	2.25	1.30	0.10	32	BB4R/L-2575-BCX-R10	■	■	■	□	□
			12.5	15	13.5	0.38	2.25	1.30	0.10	37	BB4R/L-25125-BCX-R10	■	■	■	□	□
		3.0	9.0	15	13.5	0.45	2.70	1.35	0.10	37	BB4R/L-3090-BCX-R10	■	■	■	□	□
			15.0	20	18.5	0.45	2.70	1.35	0.10	42	BB4R/L-30150-BCX-R10	■	■	■	□	□
		3.5	10.5	15	13.5	0.53	3.15	1.60	0.10	37	BB4R/L-35105-BCX-R10	■	■	■	□	□
			17.5	20	18.5	0.53	3.15	1.60	0.10	42	BB4R/L-35175-BCX-R10	■	■	■	□	□
D h5	Holder	Ø min	L1	L2 BH6... BHY6...	L2 BHS6... BHK6...	T	E	C	R	L3	Art. N°	ZTAF	ZTAXF	ZN	ZTAF	ZN
6	BH6... BHS6... BHY6... BHK6...	4.0	12.0	20	18.5	0.60	3.80	2.20	0.15	47	BB6R/L-40120-BCX-R15	■	■	■	□	□
			20.0	30	28.5	0.60	3.80	2.20	0.15	57	BB6R/L-40200-BCX-R15	■	■	■	□	□
		4.5	13.5	20	18.5	0.68	4.28	2.30	0.15	47	BB6R/L-45135-BCX-R15	■	■	■	□	□
			22.5	30	28.5	0.68	4.28	2.30	0.15	57	BB6R/L-45225-BCX-R15	■	■	■	□	□
		5.0	15.0	20	18.5	0.75	4.75	2.40	0.15	47	BB6R/L-50150-BCX-R15	■	■	■	□	□
			25.0	30	28.5	0.75	4.75	2.40	0.15	57	BB6R/L-50250-BCX-R15	■	■	■	□	□
		5.5	16.5	20	18.5	0.83	5.15	2.60	0.15	47	BB6R/L-55165-BCX-R15	■	■	■	□	□
			27.5	30	28.5	0.83	5.15	2.60	0.15	57	BB6R/L-55275-BCX-R15	■	■	■	□	□

Alésage-copiage
 Ausbohren-kopieren
 Boring chambering

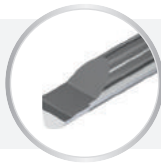

BF4... / BF6...

BCX

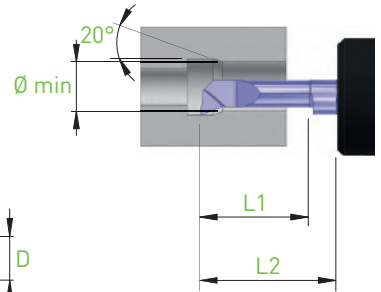
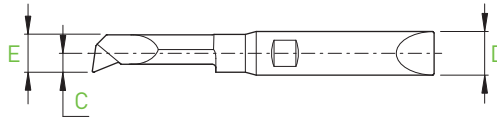
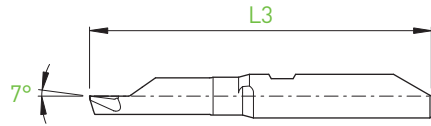
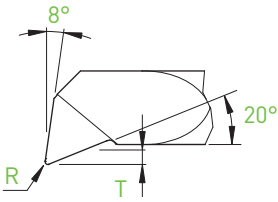

D h5	Holder	Ø min	L1	L2 BH4... BHY4...	L2 BHS4... BHK4...	T	E	C	R	L3	Art. N°	R		L		
												ZTAF	ZTAXF	ZN	ZTAF	ZN
4	BH4... BHS4... BHY4... BHK4...	1.0	3.0	10	8.5	0.15	0.90	0.70	0.05	32	BF4R/L-1030-BCX-R05	■	■	■	□	□
			5.0	10	8.5	0.15	0.90	0.70	0.05	32	BF4R/L-1050-BCX-R05	■	■	■	□	□
		1.5	4.5	10	8.5	0.23	1.35	0.75	0.05	32	BF4R/L-1545-BCX-R05	■	■	■	□	□
			7.5	10	8.5	0.23	1.35	0.75	0.05	32	BF4R/L-1575-BCX-R05	■	■	■	□	□
		2.0	6.0	10	8.5	0.30	1.80	1.15	0.05	32	BF4R/L-2060-BCX-R05	■	■	■	□	□
			10.0	15	13.5	0.30	1.80	1.15	0.05	37	BF4R/L-20100-BCX-R05	■	■	■	□	□
		2.5	7.5	10	8.5	0.38	2.25	1.30	0.10	32	BF4R/L-2575-BCX-R10	■	■	■	□	□
			12.5	15	13.5	0.38	2.25	1.30	0.10	37	BF4R/L-25125-BCX-R10	■	■	■	□	□
		3.0	9.0	15	13.5	0.45	2.70	1.35	0.10	37	BF4R/L-3090-BCX-R10	■	■	■	□	□
			15.0	20	18.5	0.45	2.70	1.35	0.10	42	BF4R/L-30150-BCX-R10	■	■	■	□	□
		3.5	10.5	15	13.5	0.53	3.15	1.60	0.10	37	BF4R/L-35105-BCX-R10	■	■	■	□	□
			17.5	20	18.5	0.53	3.15	1.60	0.10	42	BF4R/L-35175-BCX-R10	■	■	■	□	□
D h5	Holder	Ø min	L1	L2 BH6... BHY6...	L2 BHS6... BHK6...	T	E	C	R	L3	Art. N°	ZTAF	ZTAXF	ZN	ZTAF	ZN
6	BH6... BHS6... BHY6... BHK6...	4.0	12.0	20	18.5	0.60	3.80	2.20	0.15	47	BF6R/L-40120-BCX-R15	■	■	■	□	□
			20.0	30	28.5	0.60	3.80	2.20	0.15	57	BF6R/L-40200-BCX-R15	■	■	■	□	□
		4.5	13.5	20	18.5	0.68	4.28	2.30	0.15	47	BF6R/L-45135-BCX-R15	■	■	■	□	□
			22.5	30	28.5	0.68	4.28	2.30	0.15	57	BF6R/L-45225-BCX-R15	■	■	■	□	□
		5.0	15.0	20	18.5	0.75	4.75	2.40	0.15	47	BF6R/L-50150-BCX-R15	■	■	■	□	□
			25.0	30	28.5	0.75	4.75	2.40	0.15	57	BF6R/L-50250-BCX-R15	■	■	■	□	□
		5.5	16.5	20	18.5	0.83	5.15	2.60	0.15	47	BF6R/L-55165-BCX-R15	■	■	■	□	□
			27.5	30	28.5	0.83	5.15	2.60	0.15	57	BF6R/L-55275-BCX-R15	■	■	■	□	□

■ = disponible / verfügbar / available
 □ = selon disponibilité du stock / jenach Lagerverfügbarkeit / depending the stock availability

- Copiage
- Kopieren
- Chamfering

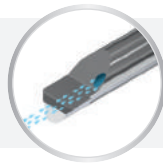

BB4... / BB6...

C45

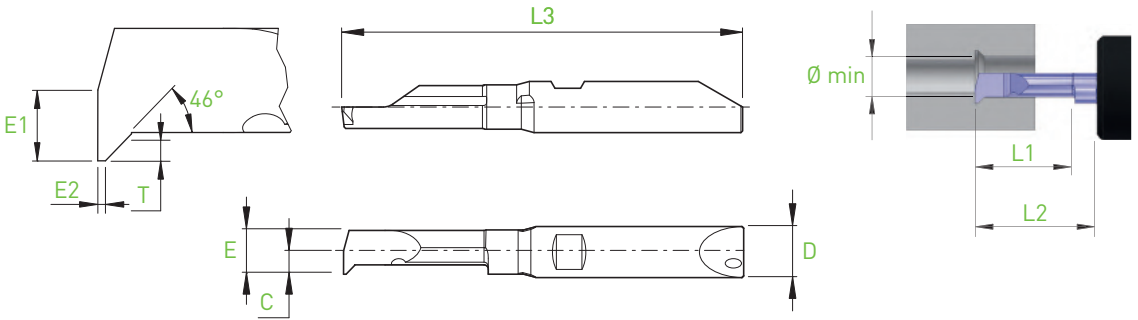

D h5	Holder	Ø min	L1	L2 BH4... BHY4...	L2 BHS4... BHK4...	T	E	E1	C	E2	L3	Art. N°	R		L	
													ZTAF	ZTAXF	ZN	ZTAF
4	BH4... BHS4... BHY4... BHK4...	0.3	0.6	10	8.5	0.05	0.27	0.13	0.15	0.03	32	BB4R/L-0306-C45-E03	<input type="checkbox"/>	<input type="checkbox"/>	<input type="checkbox"/>	<input type="checkbox"/>
		0.4	0.8	10	8.5	0.07	0.36	0.18	0.20	0.03	32	BB4R/L-0408-C45-E03	<input type="checkbox"/>	<input type="checkbox"/>	<input type="checkbox"/>	<input type="checkbox"/>
		0.5	1.0	10	8.5	0.08	0.45	0.22	0.25	0.03	32	BB4R/L-0510-C45-E03	<input type="checkbox"/>	<input type="checkbox"/>	<input type="checkbox"/>	<input type="checkbox"/>
		0.6	1.2	10	8.5	0.10	0.54	0.27	0.30	0.03	32	BB4R/L-0612-C45-E03	<input type="checkbox"/>	<input type="checkbox"/>	<input type="checkbox"/>	<input type="checkbox"/>
		0.7	1.2	10	8.5	0.12	0.63	0.32	0.35	0.03	32	BB4R/L-0714-C45-E03	<input type="checkbox"/>	<input type="checkbox"/>	<input type="checkbox"/>	<input type="checkbox"/>
		0.8	1.6	10	8.5	0.14	0.72	0.36	0.40	0.05	32	BB4R/L-0816-C45-E05	<input type="checkbox"/>	<input type="checkbox"/>	<input type="checkbox"/>	<input type="checkbox"/>
		0.9	1.8	10	8.5	0.15	0.81	0.41	0.45	0.05	32	BB4R/L-0918-C45-E05	<input type="checkbox"/>	<input type="checkbox"/>	<input type="checkbox"/>	<input type="checkbox"/>
		1.0	3.0	10	8.5	0.17	0.90	0.45	0.70	0.10	32	BB4R/L-1030-C45-E10	<input type="checkbox"/>	<input type="checkbox"/>	<input type="checkbox"/>	<input type="checkbox"/>
		1.2	3.6	10	8.5	0.20	1.08	0.54	0.70	0.10	32	BB4R/L-1236-C45-E10	<input type="checkbox"/>	<input type="checkbox"/>	<input type="checkbox"/>	<input type="checkbox"/>
		1.5	4.5	10	8.5	0.25	1.35	0.67	0.75	0.10	32	BB4R/L-1545-C45-E10	<input type="checkbox"/>	<input type="checkbox"/>	<input type="checkbox"/>	<input type="checkbox"/>
		2.0	6.0	10	8.5	0.34	1.80	0.90	1.15	0.20	32	BB4R/L-2060-C45-E20	<input type="checkbox"/>	<input type="checkbox"/>	<input type="checkbox"/>	<input type="checkbox"/>
		2.5	7.5	10	8.5	0.43	2.25	1.13	1.30	0.20	32	BB4R/L-2575-C45-E20	<input type="checkbox"/>	<input type="checkbox"/>	<input type="checkbox"/>	<input type="checkbox"/>
3.0	9.0	15	13.5	0.51	2.70	1.35	1.35	0.30	37	BB4R/L-3090-C45-E30	<input type="checkbox"/>	<input type="checkbox"/>	<input type="checkbox"/>	<input type="checkbox"/>		
3.5	10.5	15	13.5	0.60	3.15	1.58	1.60	0.30	37	BB4R/L-35105-C45-E30	<input type="checkbox"/>	<input type="checkbox"/>	<input type="checkbox"/>	<input type="checkbox"/>		
6	BH6... BHS6... BHY6... BHK6...	4.0	12.0	20	18.5	0.68	3.80	1.90	2.30	0.40	47	BB6R/L-40120-C45-E40	<input type="checkbox"/>	<input type="checkbox"/>	<input type="checkbox"/>	<input type="checkbox"/>
		5.0	15.0	20	18.5	0.85	4.75	2.37	2.50	0.50	47	BB6R/L-50150-C45-E50	<input type="checkbox"/>	<input type="checkbox"/>	<input type="checkbox"/>	<input type="checkbox"/>

new

- Copiage
- Kopieren
- Chambering



BF4... / BF6...

C45

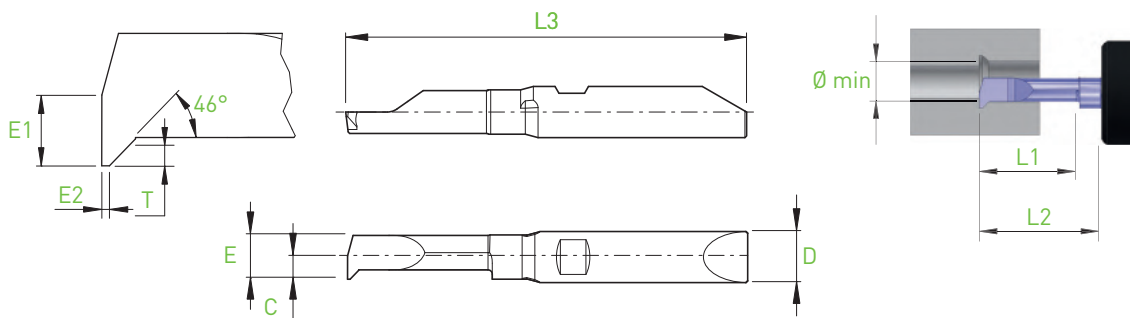

D h5	Holder	Ø min	L1	L2 BH4... BHY4...	L2 BHS4... BHK4...	T	E	E1	C	E2	L3	Art. N°	R		L		
													ZTAF	ZTAXF	ZN	ZTAF	ZN
4	BH4... BHS4... BHY4... BHK4...	0.3	0.6	10	8.5	0.05	0.27	0.13	0.15	0.03	32	BF4R/L-0306-C45-E03	■	■	■	□	□
		0.4	0.8	10	8.5	0.07	0.36	0.18	0.20	0.03	32	BF4R/L-0408-C45-E03	■	■	■	□	□
		0.5	1.0	10	8.5	0.08	0.45	0.22	0.25	0.03	32	BF4R/L-0510-C45-E03	■	■	■	□	□
		0.6	1.2	10	8.5	0.10	0.54	0.27	0.30	0.03	32	BF4R/L-0612-C45-E03	■	■	■	□	□
		0.7	1.2	10	8.5	0.12	0.63	0.32	0.35	0.03	32	BF4R/L-0714-C45-E03	■	■	■	□	□
		0.8	1.6	10	8.5	0.14	0.72	0.36	0.40	0.05	32	BF4R/L-0816-C45-E05	■	■	■	□	□
		0.9	1.8	10	8.5	0.15	0.81	0.41	0.45	0.05	32	BF4R/L-0918-C45-E05	■	■	■	□	□
		1.0	3.0	10	8.5	0.17	0.90	0.45	0.70	0.10	32	BF4R/L-1030-C45-E10	■	■	■	□	□
		1.2	3.6	10	8.5	0.20	1.08	0.54	0.70	0.10	32	BF4R/L-1236-C45-E10	■	■	■	□	□
		1.5	4.5	10	8.5	0.25	1.35	0.67	0.75	0.10	32	BF4R/L-1545-C45-E10	■	■	■	□	□
		2.0	6.0	10	8.5	0.34	1.80	0.90	1.15	0.20	32	BF4R/L-2060-C45-E20	■	■	■	□	□
		2.5	7.5	10	8.5	0.43	2.25	1.13	1.30	0.20	32	BF4R/L-2575-C45-E20	■	■	■	□	□
3.0	9.0	15	13.5	0.51	2.70	1.35	1.35	0.30	37	BF4R/L-3090-C45-E30	■	■	■	□	□		
3.5	10.5	15	13.5	0.60	3.15	1.58	1.60	0.30	37	BF4R/L-35105-C45-E30	■	■	■	□	□		
6	BH6... BHS6... BHY6... BHK6...	4.0	12.0	20	18.5	0.68	3.80	1.90	2.30	0.40	47	BF6R/L-40120-C45-E40	■	■	■	□	□
		5.0	15.0	20	18.5	0.85	4.75	2.37	2.50	0.50	47	BF6R/L-50150-C45-E50	■	■	■	□	□

■ = disponible / verfügbar / available
 □ = selon disponibilité du stock / jenach Lagerverfügbarkeit / depending the stock availability

Copiage
Kopieren
Chamfering

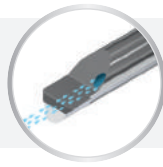

BB4... / BB6...

C45X

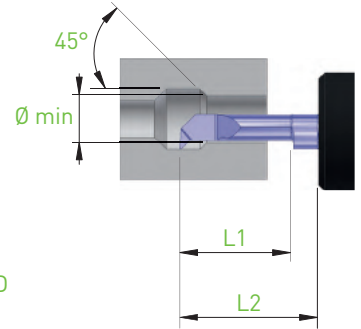
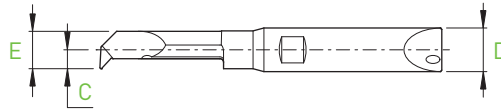
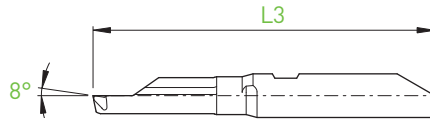
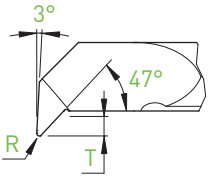

D h5	Holder	Ø min	L1	L2 BH4... BHY4...	L2 BHS4... BHK4...	T	E	C	R	L3	Art. N°	R		L	
												ZTAF	ZTAXF	ZN	ZTAF
4	BH4... BHS4... BHY4... BHK4...	2.5	7.5	10	8.5	0.50	2.25	1.35	0.10	32	BB4R/L-2575-C45X-R10	<input checked="" type="checkbox"/>	<input checked="" type="checkbox"/>	<input type="checkbox"/>	<input type="checkbox"/>
			12.5	15	13.5	0.50	2.25	1.35	0.10	37	BB4R/L-25125-C45X-R10	<input checked="" type="checkbox"/>	<input checked="" type="checkbox"/>	<input type="checkbox"/>	<input type="checkbox"/>
		3.0	9.0	15	13.5	0.60	2.70	1.45	0.10	37	BB4R/L-3090-C45X-R10	<input checked="" type="checkbox"/>	<input checked="" type="checkbox"/>	<input type="checkbox"/>	<input type="checkbox"/>
			15.0	20	18.5	0.60	2.70	1.45	0.10	42	BB4R/L-30150-C45X-R10	<input checked="" type="checkbox"/>	<input checked="" type="checkbox"/>	<input type="checkbox"/>	<input type="checkbox"/>
		3.5	10.5	15	13.5	0.70	3.15	1.60	0.10	37	BB4R/L-35105-C45X-R10	<input checked="" type="checkbox"/>	<input checked="" type="checkbox"/>	<input type="checkbox"/>	<input type="checkbox"/>
			17.5	20	18.5	0.70	3.15	1.60	0.10	42	BB4R/L-35175-C45X-R10	<input checked="" type="checkbox"/>	<input checked="" type="checkbox"/>	<input type="checkbox"/>	<input type="checkbox"/>
6	BH6... BHS6... BHY6... BHK6...	4.0	12.0	20	18.5	0.80	3.80	2.30	0.15	47	BB6R/L-40120-C45X-R15	<input checked="" type="checkbox"/>	<input checked="" type="checkbox"/>	<input type="checkbox"/>	<input type="checkbox"/>
			20.0	30	28.5	0.80	3.80	2.30	0.15	57	BB6R/L-40200-C45X-R15	<input checked="" type="checkbox"/>	<input checked="" type="checkbox"/>	<input type="checkbox"/>	<input type="checkbox"/>
		4.5	13.5	20	18.5	0.90	4.28	2.40	0.15	47	BB6R/L-45135-C45X-R15	<input checked="" type="checkbox"/>	<input checked="" type="checkbox"/>	<input type="checkbox"/>	<input type="checkbox"/>
			22.5	30	28.5	0.90	4.28	2.40	0.15	57	BB6R/L-45225-C45X-R15	<input checked="" type="checkbox"/>	<input checked="" type="checkbox"/>	<input type="checkbox"/>	<input type="checkbox"/>
		5.0	15.0	20	18.5	1.00	4.75	2.50	0.15	47	BB6R/L-50150-C45X-R15	<input checked="" type="checkbox"/>	<input checked="" type="checkbox"/>	<input type="checkbox"/>	<input type="checkbox"/>
			25.0	30	28.5	1.00	4.75	2.50	0.15	57	BB6R/L-50250-C45X-R15	<input checked="" type="checkbox"/>	<input checked="" type="checkbox"/>	<input type="checkbox"/>	<input type="checkbox"/>
		5.5	16.5	20	18.5	1.10	5.15	2.60	0.15	47	BB6R/L-55165-C45X-R15	<input checked="" type="checkbox"/>	<input checked="" type="checkbox"/>	<input type="checkbox"/>	<input type="checkbox"/>
			27.5	30	28.5	1.10	5.15	2.60	0.15	57	BB6R/L-55275-C45X-R15	<input checked="" type="checkbox"/>	<input checked="" type="checkbox"/>	<input type="checkbox"/>	<input type="checkbox"/>

Copiage
Kopieren
Chambering

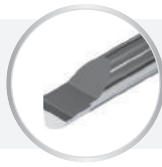

BF4... / BF6...

C45X

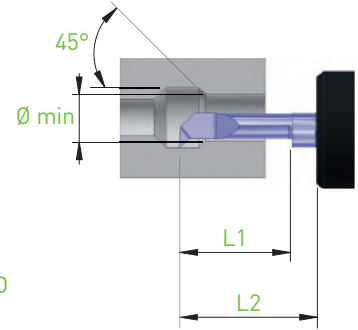
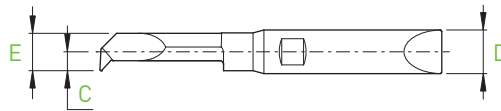
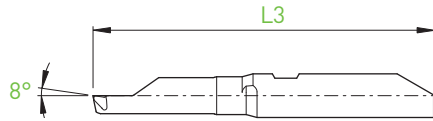
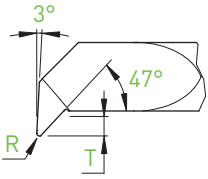

D _{h5}	Holder	Ø min	L1	L2 BH4... BHY4...	L2 BHS4... BHK4...	T	E	C	R	L3	Art. N°	R		L		
												ZTAF	ZTAXF	ZN	ZTAF	ZN
4	BH4... BHS4... BHY4... BHK4...	2.5	7.5	10	8.5	0.50	2.25	1.35	0.10	32	BF4R/L-2575-C45X-R10	■	■	■	□	□
			12.5	15	13.5	0.50	2.25	1.35	0.10	37	BF4R/L-25125-C45X-R10	■	■	■	□	□
		3.0	9.0	15	13.5	0.60	2.70	1.45	0.10	37	BF4R/L-3090-C45X-R10	■	■	■	□	□
			15.0	20	18.5	0.60	2.70	1.45	0.10	42	BF4R/L-30150-C45X-R10	■	■	■	□	□
		3.5	10.5	15	13.5	0.70	3.15	1.60	0.10	37	BF4R/L-35105-C45X-R10	■	■	■	□	□
			17.5	20	18.5	0.70	3.15	1.60	0.10	42	BF4R/L-35175-C45X-R10	■	■	■	□	□
6	BH6... BHS6... BHY6... BHK6...	4.0	12.0	20	18.5	0.80	3.80	2.30	0.15	47	BF6R/L-40120-C45X-R15	■	■	■	□	□
			20.0	30	28.5	0.80	3.80	2.30	0.15	57	BF6R/L-40200-C45X-R15	■	■	■	□	□
		4.5	13.5	20	18.5	0.90	4.28	2.40	0.15	47	BF6R/L-45135-C45X-R15	■	■	■	□	□
			22.5	30	28.5	0.90	4.28	2.40	0.15	57	BF6R/L-45225-C45X-R15	■	■	■	□	□
		5.0	15.0	20	18.5	1.00	4.75	2.50	0.15	47	BF6R/L-50150-C45X-R15	■	■	■	□	□
			25.0	30	28.5	1.00	4.75	2.50	0.15	57	BF6R/L-50250-C45X-R15	■	■	■	□	□
		5.5	16.5	20	18.5	1.10	5.15	2.60	0.15	47	BF6R/L-55165-C45X-R15	■	■	■	□	□
			27.5	30	28.5	1.10	5.15	2.60	0.15	57	BF6R/L-55275-C45X-R15	■	■	■	□	□

■ = disponible / verfügbar / available
□ = selon disponibilité du stock / jenach Lagerverfügbarkeit / depending the stock availability

IN-LINE

Gorge
Einstecken
Grooving

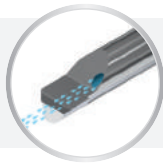

BB4... / BB6...

GX

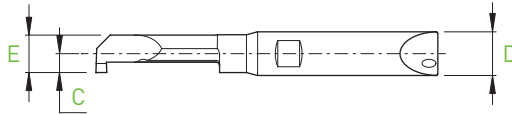
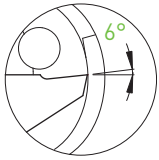
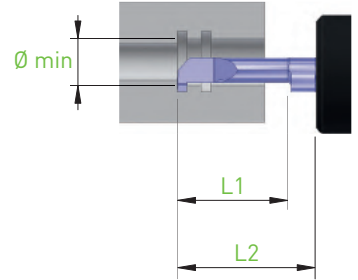
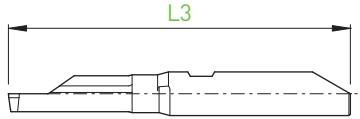
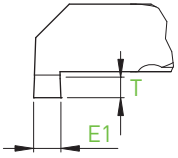

D _{h5}	Holder	Ø min	L1	L2 BH4... BHY4...	L2 BHS4... BHK4...	E1	T	E	C	L3	Art. N°	R			L				
												ZTAF	ZTAXF	ZN	ZTAF	ZN	ZN		
4	BH4... BHS4... BHY4... BHK4...	3.0	9.0	15	13.5	0.50	0.60	2.70	1.45	37	BB4R/L-3090-G050X	■	■	■	□	□	□		
			15.0	20	18.5	0.50	0.60	2.70	1.45	42	BB4R/L-30150-G050X	■	■	■	□	□	□		
		3.5	10.5	15	13.5	0.75	0.70	3.15	1.60	37	BB4R/L-35105-G075X	■	■	■	□	□	□		
			17.5	20	18.5	0.75	0.70	3.15	1.60	42	BB4R/L-35175-G075X	■	■	■	□	□	□		
6	BH6... BHS6... BHY6... BHK6...	4.0	12.0	20	18.5	1.00	0.80	3.80	2.20	47	BB6R/L-40120-G100X	■	■	■	□	□	□		
			20.0	30	28.5	1.00	0.80	3.80	2.20	57	BB6R/L-40200-G100X	■	■	■	□	□	□		
			4.5	13.5	20	18.5	1.00 1.50	0.90	4.28	2.40	47	BB6R/L-45135-G100X BB6R/L-45135-G150X	■	■	■	□	□	□	
				22.5	30	28.5	1.00 1.50	0.90	4.28	2.40	57	BB6R/L-45225-G100X BB6R/L-45225-G150X	■	■	■	□	□	□	
		5.0	15.0	15.0	20	18.5	1.00 1.50	1.00	4.75	2.50	47	BB6R/L-50150-G100X BB6R/L-50150-G150X	■	■	■	□	□	□	
				25.0	30	28.5	1.00 1.50	1.00	4.75	2.50	57	BB6R/L-50250-G100X BB6R/L-50250-G150X	■	■	■	□	□	□	
			5.5	16.5	16.5	20	18.5	1.00 1.50 2.00	1.10	5.15	2.60	47	BB6R/L-55165-G100X BB6R/L-55165-G150X BB6R/L-55165-G200X	■	■	■	□	□	□
					27.5	30	28.5	1.00 1.50 2.00	1.10	5.15	2.60	57	BB6R/L-55275-G100X BB6R/L-55275-G150X BB6R/L-55275-G200X	■	■	■	□	□	□

Gorge
Einstecken
Grooving

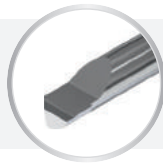

BF4... / BF6...

GX

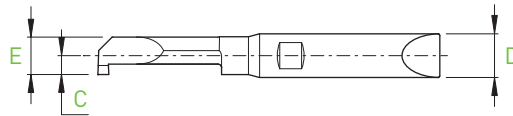
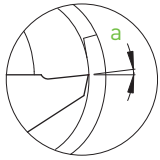
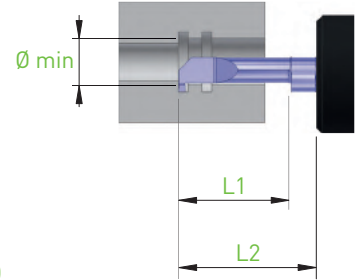
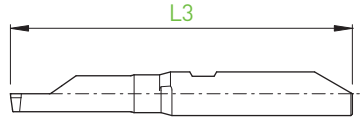
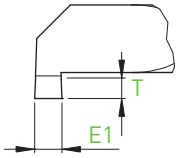

D h5	Holder	Ø min	L1	L2		E1	T	E	a	C	L3	Art. N°	R		L	
				BH4... BHY4...	BHS4... BHK4...								ZTAF	ZTAXF	ZN	ZTAF
4	BH4... BHS4... BHY4... BHK4...	0.5	1.0	10	8.5	0.15	0.10	0.45	3°	0.25	32	BF4R/L-0510-G015X	<input type="checkbox"/>	<input type="checkbox"/>	<input type="checkbox"/>	<input type="checkbox"/>
		0.7	1.4	10	8.5	0.20	0.14	0.63		0.35	32	BF4R/L-0714-G020X	<input type="checkbox"/>	<input type="checkbox"/>	<input type="checkbox"/>	<input type="checkbox"/>
		1.0	2.0	10	8.5	0.30	0.20	0.90		0.60	32	BF4R/L-1020-G030X	<input type="checkbox"/>	<input type="checkbox"/>	<input type="checkbox"/>	<input type="checkbox"/>
		1.5	3.0	10	8.5	0.40	0.30	1.35	6°	0.80	32	BF4R/L-1530-G040X	<input type="checkbox"/>	<input type="checkbox"/>	<input type="checkbox"/>	<input type="checkbox"/>
		2.0	6.0	10	8.5	0.40	0.40	1.80		1.15	32	BF4R/L-2060-G040X	<input type="checkbox"/>	<input type="checkbox"/>	<input type="checkbox"/>	<input type="checkbox"/>
		2.5	7.5	10	8.5	0.50	0.50	2.25		1.15	32	BF4R/L-2575-G050X	<input type="checkbox"/>	<input type="checkbox"/>	<input type="checkbox"/>	<input type="checkbox"/>
		3.0	9.0	15	13.5	0.50	0.60	2.70		1.45	37	BF4R/L-3090-G050X	<input type="checkbox"/>	<input type="checkbox"/>	<input type="checkbox"/>	<input type="checkbox"/>
			15.0	20	18.5	0.50	0.60	2.70		1.45	42	BF4R/L-30150-G050X	<input type="checkbox"/>	<input type="checkbox"/>	<input type="checkbox"/>	<input type="checkbox"/>
		3.5	10.5	15	13.5	0.75	0.70	3.15		1.60	37	BF4R/L-35105-G075X	<input type="checkbox"/>	<input type="checkbox"/>	<input type="checkbox"/>	<input type="checkbox"/>
			17.5	20	18.5	0.75	0.70	3.15		1.60	42	BF4R/L-35175-G075X	<input type="checkbox"/>	<input type="checkbox"/>	<input type="checkbox"/>	<input type="checkbox"/>
6	BH6... BHS6... BHY6... BHK6...	4.0	12.0	20	18.5	1.00	0.80	3.80	6°	2.20	47	BF6R/L-40120-G100X	<input type="checkbox"/>	<input type="checkbox"/>	<input type="checkbox"/>	<input type="checkbox"/>
			20.0	30	28.5	1.00	0.80	3.80		2.20	57	BF6R/L-40200-G100X	<input type="checkbox"/>	<input type="checkbox"/>	<input type="checkbox"/>	<input type="checkbox"/>
		4.5	13.5	20	18.5	1.00	0.90	4.28		2.40	47	BF6R/L-45135-G100X	<input type="checkbox"/>	<input type="checkbox"/>	<input type="checkbox"/>	<input type="checkbox"/>
			22.5	30	28.5	1.50	0.90	4.28			57	BF6R/L-45225-G100X	<input type="checkbox"/>	<input type="checkbox"/>	<input type="checkbox"/>	<input type="checkbox"/>
		5.0	15.0	20	18.5	1.00	1.00	4.75		2.50	47	BF6R/L-50150-G100X	<input type="checkbox"/>	<input type="checkbox"/>	<input type="checkbox"/>	<input type="checkbox"/>
				25.0	30	28.5	1.50	1.00			4.75	57	BF6R/L-50150-G150X	<input type="checkbox"/>	<input type="checkbox"/>	<input type="checkbox"/>
			25.0	30	28.5	1.50	1.00	4.75	57		BF6R/L-50250-G100X	<input type="checkbox"/>	<input type="checkbox"/>	<input type="checkbox"/>	<input type="checkbox"/>	
		5.5	16.5	20	18.5	1.50	1.10	5.15	2.60	47	BF6R/L-55165-G100X	<input type="checkbox"/>	<input type="checkbox"/>	<input type="checkbox"/>	<input type="checkbox"/>	
					2.00	5.15	47	BF6R/L-55165-G150X			<input type="checkbox"/>	<input type="checkbox"/>	<input type="checkbox"/>	<input type="checkbox"/>		
				2.00	5.15	47	BF6R/L-55165-G200X	<input type="checkbox"/>		<input type="checkbox"/>	<input type="checkbox"/>	<input type="checkbox"/>				
				1.00	5.15	47	BF6R/L-55275-G100X	<input type="checkbox"/>		<input type="checkbox"/>	<input type="checkbox"/>	<input type="checkbox"/>				
				1.50	5.15	57	BF6R/L-55275-G150X	<input type="checkbox"/>		<input type="checkbox"/>	<input type="checkbox"/>	<input type="checkbox"/>				
		2.00	5.15	57	BF6R/L-55275-G200X	<input type="checkbox"/>	<input type="checkbox"/>	<input type="checkbox"/>	<input type="checkbox"/>							

■ = disponible / verfügbar / available
□ = selon disponibilité du stock / jenach Lagerverfügbarkeit / depending the stock availability

IN-LINE

Fonçage-tournage
Einstecken und drehen
Grooving and turning

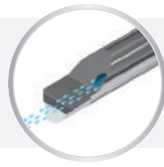

BB4... / BB6...

GTX

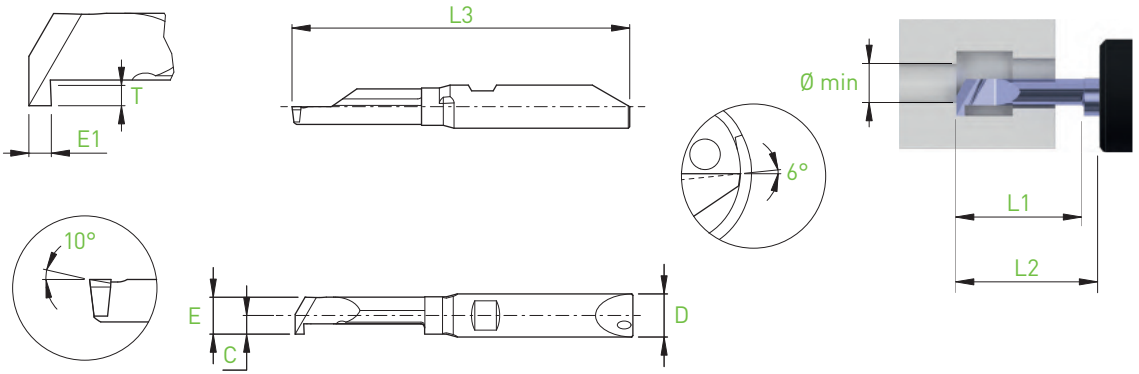

D h5	Holder	Ø min	L1	L2 BH4... BHY4...	L2 BHS4... BHK4...	E1	T	E	C	L3	Art. N°	R		L		
												ZTAF	ZTAXF	ZN	ZTAF	ZN
4	BH4... BHS4... BHY4... BHK4...	3.0	9.0	15	13.5	1.00	0.60	2.7	1.45	37	BB4R/L-3090-GT100X	■	■	■	□	□
			15.0	20	18.5	1.00	0.60	2.7	1.45	42	BB4R/L-30150-GT100X	■	■	■	□	□
	3.5	10.5	15	13.5	1.00	0.70	3.15	1.6	37	BB4R/L-35105-GT100X	■	■	■	□	□	
		17.5	20	18.5	1.00	0.70	3.15	1.6	42	BB4R/L-35175-GT100X	■	■	■	□	□	
D h5	Holder	Ø min	L1	L2 BH6... BHY6...	L2 BHS6... BHK6...	E1	T	E	C	L3	Art. N°	ZTAF	ZTAXF	ZN	ZTAF	ZN
6	BH6... BHS6... BHY6... BHK6...	4.0	14.0	20	18.5	1.25	0.80	3.8	2.2	47	BB6R/L-40140-GT125X	■	■	■	□	□
			22.0	30	28.5	1.25	0.80	3.8	2.2	57	BB6R/L-40220-GT125X	■	■	■	□	□
		4.5	16.0	20	18.5	1.25	0.90	4.28	2.4	47	BB6R/L-45160-GT125X	■	■	■	□	□
			25.0	30	28.5	1.25	0.90	4.28	2.4	57	BB6R/L-45250-GT125X	■	■	■	□	□
		5.0	17.5	20	18.5	1.25	1.00	4.75	2.5	47	BB6R/L-50175-GT125X	■	■	■	□	□
			27.5	30	28.5	1.25	1.00	4.75	2.5	57	BB6R/L-50275-GT125X	■	■	■	□	□
		5.5	17.5	20	18.5	1.25	1.10	5.15	2.6	47	BB6R/L-55175-GT125X	■	■	■	□	□
			27.5	30	28.5	1.25	1.10	5.15	2.6	57	BB6R/L-55275-GT125X	■	■	■	□	□

Fonçage-tournage
Einstechen und drehen
Grooving and turning

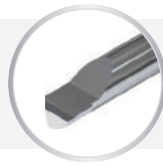

BF4... / BF6...

GTX

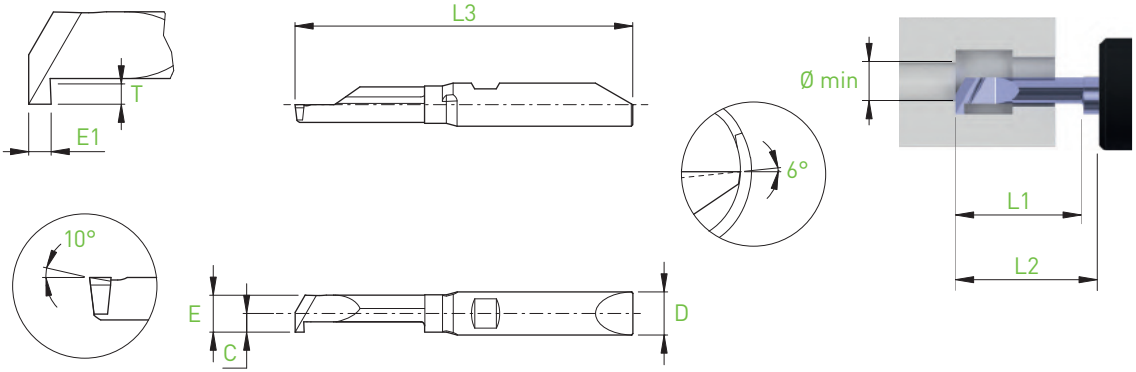

D h5	Holder	Ø min	L1	L2 BH4... BHY4...	L2 BHS4... BHK4...	E1	T	E	C	L3	Art. N°	R		L		
												ZTAF	ZTAXF	ZN	ZTAF	ZN
4	BH4... BHS4... BHY4... BHK4...	3.0	9.0	15	13.5	1.00	0.60	2.7	1.45	37	BF4R/L-3090-GT100X	■	■	■	□	□
			15.0	20	18.5	1.00	0.60	2.7	1.45	42	BF4R/L-30150-GT100X	■	■	■	□	□
	3.5	10.5	15	13.5	1.00	0.70	3.15	1.6	37	BF4R/L-35105-GT100X	■	■	■	□	□	
		17.5	20	18.5	1.00	0.70	3.15	1.6	42	BF4R/L-35175-GT100X	■	■	■	□	□	
D h5	Holder	Ø min	L1	L2 BH6... BHY6...	L2 BHS6... BHK6...	E1	T	E	C	L3	Art. N°	ZTAF	ZTAXF	ZN	ZTAF	ZN
6	BH6... BHS6... BHY6... BHK6...	4.0	14.0	20	18.5	1.25	0.80	3.8	2.2	47	BF6R/L-40140-GT125X	■	■	■	□	□
			22.0	30	28.5	1.25	0.80	3.8	2.2	57	BF6R/L-40220-GT125X	■	■	■	□	□
		4.5	16.0	20	18.5	1.25	0.90	4.28	2.4	47	BF6R/L-45160-GT125X	■	■	■	□	□
			25.0	30	28.5	1.25	0.90	4.28	2.4	57	BF6R/L-45250-GT125X	■	■	■	□	□
		5.0	17.5	20	18.5	1.25	1.00	4.75	2.5	47	BF6R/L-50175-GT125X	■	■	■	□	□
			27.5	30	28.5	1.25	1.00	4.75	2.5	57	BF6R/L-50275-GT125X	■	■	■	□	□
		5.5	17.5	20	18.5	1.25	1.10	5.15	2.6	47	BF6R/L-55175-GT125X	■	■	■	□	□
			27.5	30	28.5	1.25	1.10	5.15	2.6	57	BF6R/L-55275-GT125X	■	■	■	□	□

IN-LINE

Filetage
Gewindedrehen
Threading

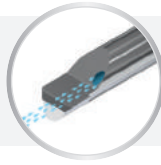

BB4... / BB6...

TP60

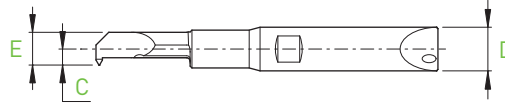
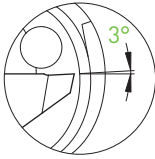
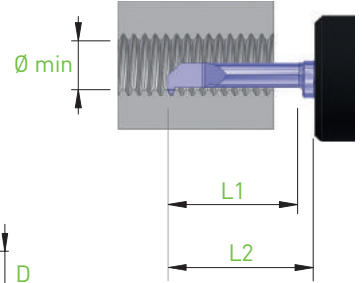
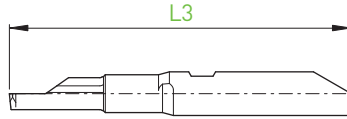
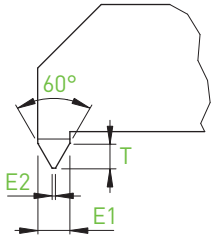

D h5	Holder	Ø min	L1	L2		P (mm)	P (TPI)	E1	E2 (0/-0.01)	T	E	C	L3	Art. N°	R		L	
				BH4... BHY4...	BHS4... BHK4...										ZTAF	ZN	ZTAF	ZN
4	BH4... BHS4... BHY4... BHK4...	1.25	3.2	10	8.5	0.20-0.35	80	0.30	0.02	0.25	1.10	0.80	32	BB4R/L-1232-TP60	■	■	□	□
		1.6	4.0	10	8.5	0.25-0.40	72-64	0.35	0.03	0.28	1.41	0.90	32	BB4R/L-1640-TP60	■	■	□	□
		2.5	6.0	10	8.5	0.35-0.50	56-48	0.44	0.04	0.34	2.25	1.35	32	BB4R/L-2560-TP60	■	■	□	□
			9.0	15	13.5	0.35-0.50	56-48	0.44	0.04	0.34	2.25	1.35	37	BB4R/L-2590-TP60	■	■	□	□
		3.3	8.0	15	13.5	0.50-0.75	40-36	0.62	0.06	0.48	2.97	1.50	37	BB4R/L-3380-TP60	■	■	□	□
12.0	15		13.5	0.50-0.75	40-36	0.62	0.06	0.48	2.97	1.50	37	BB4R/L-33120-TP60	■	■	□	□		
D h5	Holder	Ø min	L1	L2		P (mm)	P (TPI)	E1	E2 (0/-0.01)	T	E	C	L3	Art. N°	ZTAF	ZN	ZTAF	ZN
6	BH6... BHS6... BHY6... BHK6...	4.2	10.0	20	18.5	0.50-0.80	36-32	0.70	0.06	0.55	3.78	2.10	47	BB6R/L-42100-TP60	■	■	□	□
			15.0	20	18.5	0.50-0.80	36-32	0.70	0.06	0.55	3.78	2.10	47	BB6R/L-42150-TP60	■	■	□	□
		5.0	12.0	20	18.5	0.75-1.00	28-24	0.89	0.09	0.69	4.50	2.20	47	BB6R/L-50120-TP60	■	■	□	□
			18.0	20	18.5	0.75-1.00	28-24	0.89	0.09	0.69	4.50	2.20	47	BB6R/L-50180-TP60	■	■	□	□

Filetage
Gewindedrehen
Threading

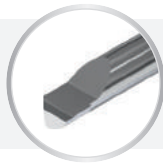

BF4... / BF6...

TP60

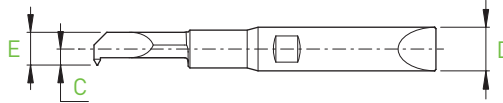
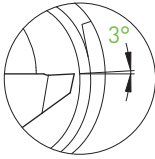
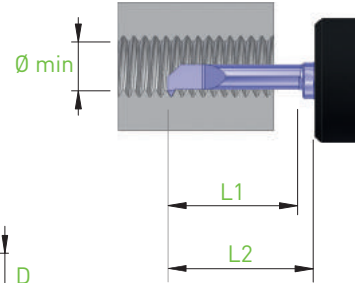
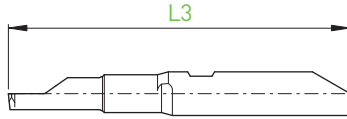
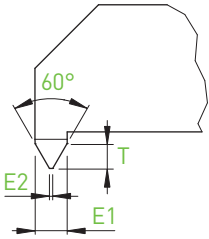

D _{h5}	Holder	Ø min	L1	L2 BH4... BHY4...	L2 BHS4... BHK4...	P (mm)	P (TPI)	E1	E2 (0/-0.01)	T	E	C	L3	Art. N°	R		L	
															ZTAF	ZN	ZTAF	ZN
4	BH4... BHS4... BHY4... BHK4...	1.25	3.2	10	8.5	0.20-0.35	80	0.30	0.02	0.25	1.10	0.80	32	BF4R/L-1232-TP60	■	■	□	□
		1.6	4.0	10	8.5	0.25-0.40	72-64	0.35	0.03	0.28	1.41	0.90	32	BF4R/L-1640-TP60	■	■	□	□
		2.5	6.0	10	8.5	0.35-0.50	56-48	0.44	0.04	0.34	2.25	1.35	32	BF4R/L-2560-TP60	■	■	□	□
			9.0	15	13.5	0.35-0.50	56-48	0.44	0.04	0.34	2.25	1.35	37	BF4R/L-2590-TP60	■	■	□	□
		3.3	8.0	15	13.5	0.50-0.75	40-36	0.62	0.06	0.48	2.97	1.50	37	BF4R/L-3380-TP60	■	■	□	□
12.0	15		13.5	0.50-0.75	40-36	0.62	0.06	0.48	2.97	1.50	37	BF4R/L-33120-TP60	■	■	□	□		
6	BH6... BHS6... BHY6... BHK6...	4.2	10.0	20	18.5	0.50-0.80	36-32	0.70	0.06	0.55	3.78	2.10	47	BF6R/L-42100-TP60	■	■	□	□
			15.0	20	18.5	0.50-0.80	36-32	0.70	0.06	0.55	3.78	2.10	47	BF6R/L-42150-TP60	■	■	□	□
		5.0	12.0	20	18.5	0.75-1.00	28-24	0.89	0.09	0.69	4.50	2.20	47	BF6R/L-50120-TP60	■	■	□	□
			18.0	20	18.5	0.75-1.00	28-24	0.89	0.09	0.69	4.50	2.20	47	BF6R/L-50180-TP60	■	■	□	□

■ = disponible / verfügbar / available
□ = selon disponibilité du stock / jenach Lagerverfügbarkeit / depending the stock availability

IN-LINE

Filetage
Gewindedrehen
Threading

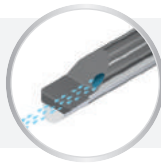

BB4... / BB6...

TP55

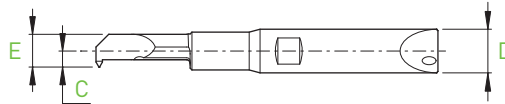
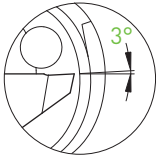
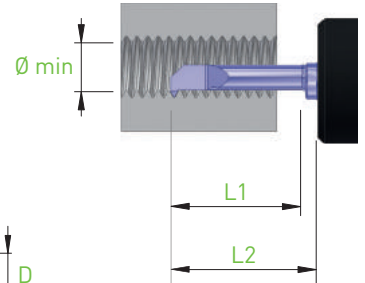
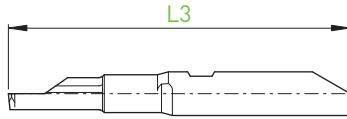
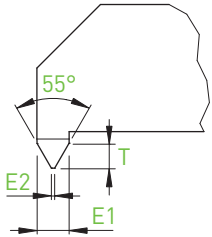

D _{h5}	Holder	Ø min	L1	L2 BH4... BHY4...	L2 BHS4... BHK4...	P (TPI)	E1	E2 [0/-0.02]	T	E	C	L3	Art. N°	R		L	
														ZTAF	ZN	ZTAF	ZN
4	BH4...	1.85	4.5	10	8.5	48	0.54	0.09	0.44	1.67	0.97	32	BB4R/L-1845-TP55	■	■	□	□
	BHS4... BHY4... BHK4...	2.55	6.0	10	8.5	40	0.64	0.10	0.52	2.25	1.35	32	BB4R/L-2560-TP55	■	■	□	□
D _{h5}	Holder	Ø min	L1	L2 BH6... BHY6...	L2 BHS6... BHK6...	P (TPI)	E1	E2 [0/-0.02]	T	E	C	L3	Art. N°	ZTAF	ZN	ZTAF	ZN
6	BH6...	3.70	11.0	20	18.5	32-24	1.08	0.13	0.91	3.33	1.83	47	BB6R/L-37110-TP55	■	■	□	□
	BHS6... BHY6... BHK6...	5.10	15.0	20	18.5	26-20	1.30	0.16	1.09	4.60	2.05	47	BB6R/L-51150-TP55	■	■	□	□
	BH6...	5.50	16.0	20	18.5	22-16	1.48	0.19	1.24	5.15	2.60	47	BB6R/L-55160-TP55	■	■	□	□

Filetage
Gewindedrehen
Threading



BF4... / BF6...

TP55

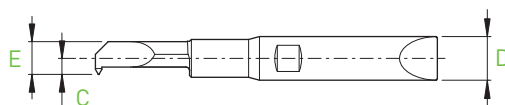
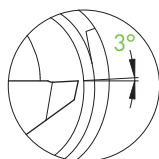
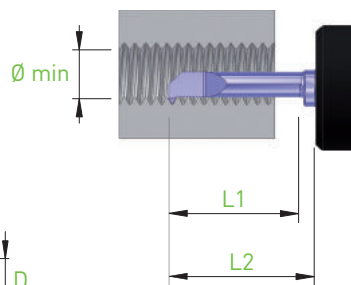
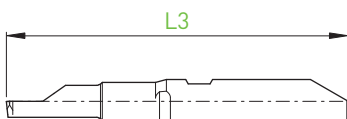
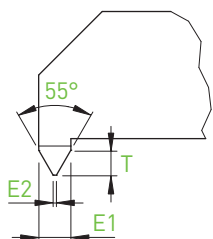

D _{h5}	Holder	Ø min	L1	L2 BH4... BHY4...	L2 BHS4... BHK4...	P (TPI)	E1	E2 (0/-0.02)	T	E	C	L3	Art. N°	R		L	
														ZTAF	ZN	ZTAF	ZN
4	BH4...	1.85	4.5	10	8.5	48	0.54	0.09	0.44	1.67	0.97	32	BF4R/L-1845-TP55	■	■	□	□
	BHS4...																
	BHY4... BHK4...	2.55	6.0	10	8.5	40	0.64	0.10	0.52	2.25	1.35	32	BF4R/L-2560-TP55	■	■	□	□
D _{h5}	Holder	Ø min	L1	L2 BH6... BHY6...	L2 BHS6... BHK6...	P (TPI)	E1	E2 (0/-0.02)	T	E	C	L3	Art. N°	ZTAF	ZN	ZTAF	ZN
6	BH6...	3.70	11.0	20	18.5	32-24	1.08	0.13	0.91	3.33	1.83	47	BF6R/L-37110-TP55	■	■	□	□
	BHS6...	5.10	15.0	20	18.5	26-20	1.30	0.16	1.09	4.60	2.05	47	BF6R/L-51150-TP55	■	■	□	□
	BHY6...																
	BHK6...	5.50	16.0	20	18.5	22-16	1.48	0.19	1.24	5.15	2.60	47	BF6R/L-55160-TP55	■	■	□	□

■ = disponible / verfügbar / available
□ = selon disponibilité du stock / jenach Lagerverfügbarkeit / depending the stock availability

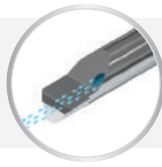

Profil complet métrique
Metrisches Vollprofil
Metric full profile

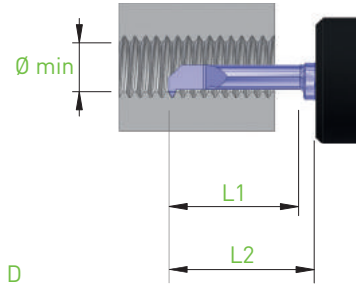
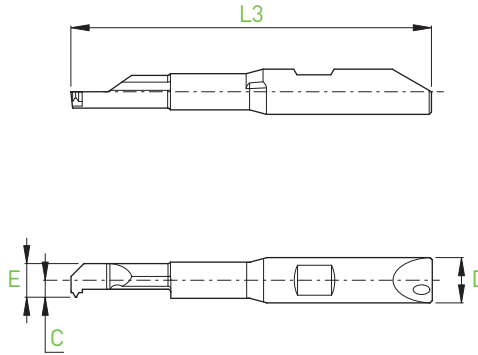
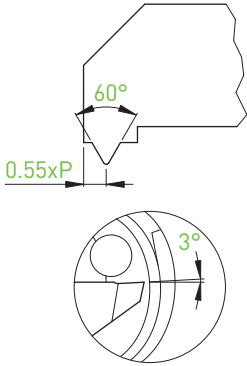

D _{h5}	Holder	M (min)	Ø min	P (mm)	L1	L2 BH4... BHY4...	L2 BHS4... BHK4...	E	C	L3	Art. N°	R	
												ZTAF	ZN
4	BH4... BHS4... BHY4... BHK4...	M3x0.5	2.50	0.50	6.0	10	8.5	2.25	1.35	32	BB4R-2560-TM-0.50	■	■
		M4x0.7	3.30	0.70	8.0	15	13.5	2.97	1.50	37	BB4R-3380-TM-0.70	■	■
D _{h5}	Holder	M (min)	Ø min	P (mm)	L1	L2 BH6... BHY6...	L2 BHS6... BHK6...	E	C	L3	Art. N°	ZTAF	ZN
6	BH6... BHS6... BHY6... BHK6...	M5x0.8	4.20	0.80	10.0	20	18.5	3.78	2.10	47	BB6R-42100-TM-0.80	■	■
		M6x1.0	5.00	1.00	12.0	20	18.5	4.50	2.20	47	BB6R-50120-TM-1.00	■	■

Filetage
Gewindedrehen
Threading

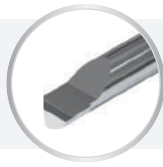

BF4... / BF6...

TM

Profil complet métrique
Metrisches Vollprofil
Metric full profile

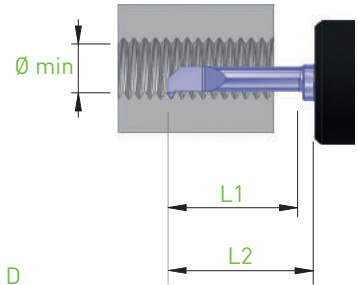
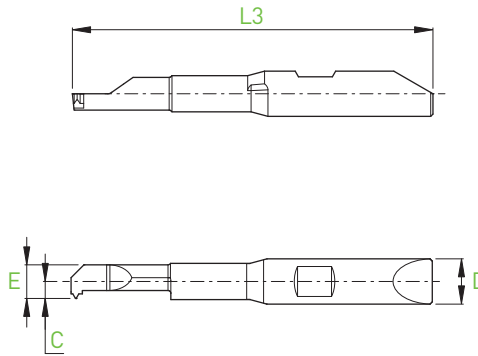
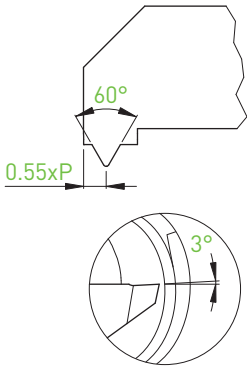

R

D h5	Holder	M (min)	Ø min	P (mm)	L1	L2 BH4... BHY4...	L2 BHS4... BHK4...	E	C	L3	Art. N°	ZTAF	ZN
4	BH4... BHS4... BHY4... BHK4...	M3x0.5	2.50	0.50	6.0	10	8.5	2.25	1.35	32	BF4R-2560-TM-0.50	■	■
		M4x0.7	3.30	0.70	8.0	15	13.5	2.97	1.50	37	BF4R-3380-TM-0.70	■	■
D h5	Holder	M (min)	Ø min	P (mm)	L1	L2 BH6... BHY6...	L2 BHS6... BHK6...	E	C	L3	Art. N°	ZTAF	ZN
6	BH6... BHS6... BHY6... BHK6...	M5x0.8	4.20	0.80	10.0	20	18.5	3.78	2.10	47	BF6R-42100-TM-0.80	■	■
		M6x1.0	5.00	1.00	12.0	20	18.5	4.50	2.20	47	BF6R-50120-TM-1.00	■	■

IN-LINE

- Gorge frontale extérieure
- Aussen axiales stechen
- External axial grooving

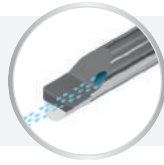

BB6...

FEG

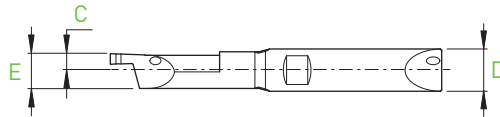
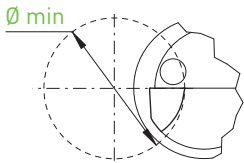
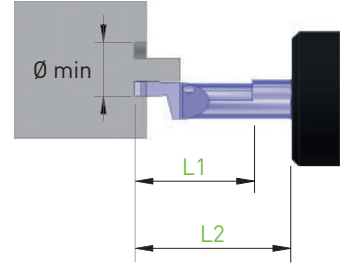
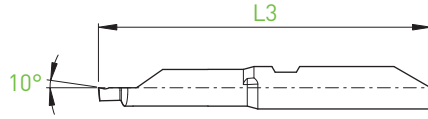
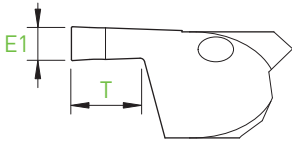

R

D h5	Holder	Ø min	L1	L2 BH6... BHY6...	L2 BHS6... BHK6...	T	E	C	E1	L3	Art. N°	ZTAF	ZN
6	BH6... BHS6... BHY6... BHK6...	5.0	15.0	20	18.5	3.00	4.90	2.30	1.50	47	BB6R-50150-FEG150X	■	■

P
 M
 N
 S
 P
 N
 S

Gorge frontale intérieure

Innen axiales stechen

Internal axial grooving

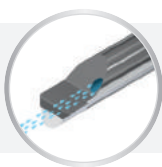

BB6...

FIG

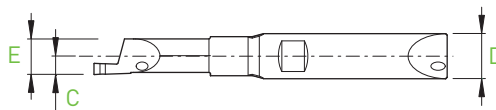
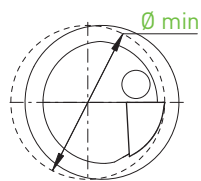
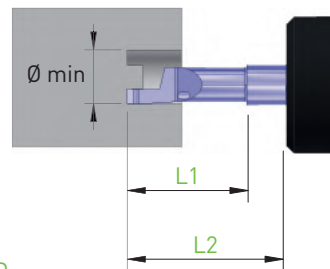
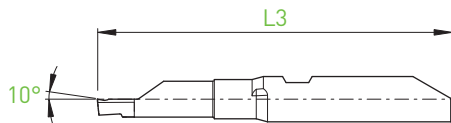
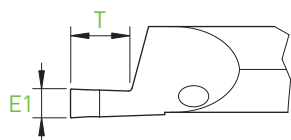

R

D h5	Holder	Ø min	L1	L2 BH6... BHY6...	L2 BHS6... BHK6...	T	E	C	E1	L3	Art. N°	ZTAF	ZN
6	BH6... BHS6... BHY6... BHK6...	5.0	15.0	20	18.5	3.00	4.75	2.45	1.50	47	BB6R-50150-FIG150X	■	■

■ = disponible / verfügbar / available

□ = selon disponibilité du stock / jenach Lagerverfügbarkeit / depending the stock availability

IN-LINE

Ébauches avec arrosage
 Rohlinge mit Kühlung
 Blanks with coolant

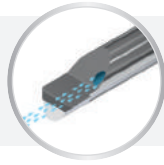

BB4... / BB6...

BB_E

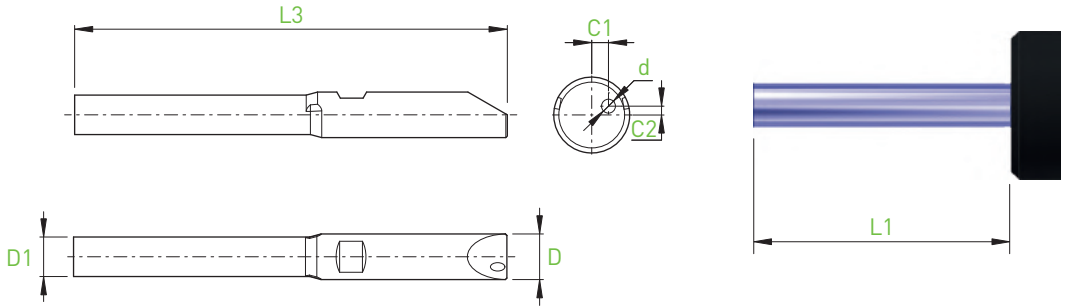

D h5	Holder	L1 BH4... BHY4...	L1 BHS4... BHK4...	D1	C1	C2	d	L3	Art. N°	ZN
4	BH4... BHS4... BHY4... BHK4...	20.0	18.5	3.20	0.84	0.55	0.85	42	BB4R-E42	■
D h5	Holder	L1 BH6... BHY6...	L1 BHS6... BHK6...	D1	C1	C2	d	L3	Art. N°	ZN
6	BH6... BHS6... BHY6... BHK6...	30.0	28.5	5.20	1.33	0.70	1.10	57	BB6R-E57	■

Ébauches

Rohlinge

Blanks



BF4... / BF6...

BF_E

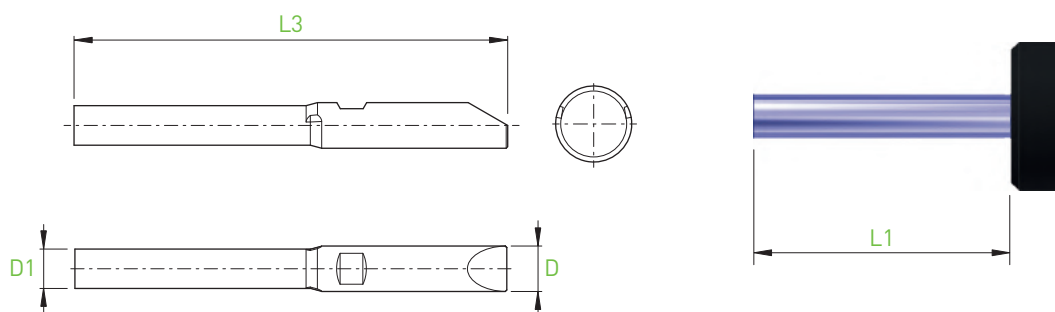

D_{h5}	Holder	L1 BH4... BHY4...	L1 BHS4... BHK4...	D1	L3	Art. N°	ZN
4	BH4... BHS4... BHY4... BHK4...	20.0	18.5	3.20	42	BF4-E42	■
D_{h5}	Holder	L1 BH6... BHY6...	L1 BHS6... BHK6...	D1	L3	Art. N°	ZN
6	BH6... BHS6... BHY6... BHK6...	30.0	28.5	5.20	57	BF6-E57	■

IN-LINE

Jauges d'alignement
Richtplatten
Adjusting tools

MASTER

BH4 / BH6

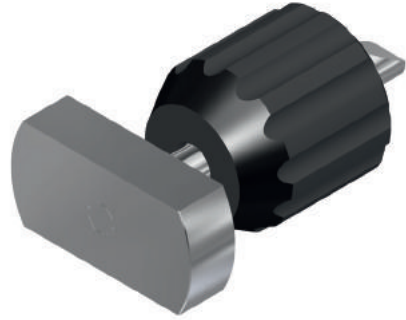
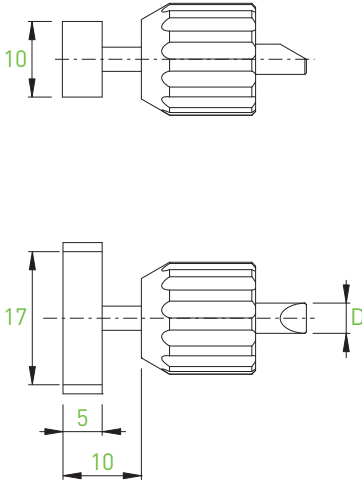

D h5	Art. N°	
4	BH4-MASTER	■
6	BH6-MASTER	■

Jauges d'alignement
Richtplatten
Adjusting tools

MASTER

BHSY...

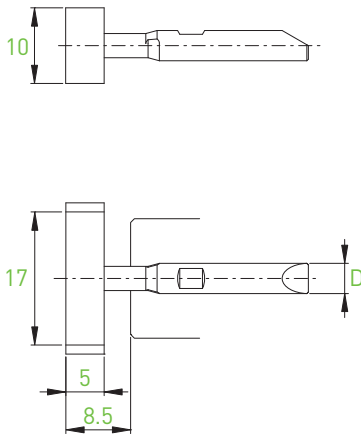

D h5	Art. N°	
4	BHSY4-MASTER	■
6	BHSY6-MASTER	■

Porte-outils avec arrosage pour contre-opération - Machines STAR
 Halter mit Kühlungssystem für Gegenbearbeitung – STAR-Maschinen
 Backworking holders with through coolant – STAR-Machines

BH4 / BH6
 BHS4 / BHS6

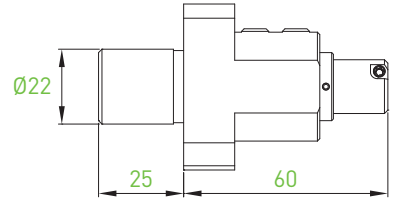
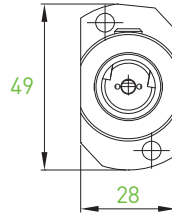

Art. N°

BWD1-2022-STAR-SRR

Art. N°

BHS4-D20-55-BWD1
 BHS6-D20-55-BWD1

Types of STAR machines

SR10J (T22+T24)
 SB16/20 Types C + D + E (T21-T24)
 SB20R Types E + G + N (T21-T24)
 SR20J / JN (T21-T24)
 SR20R / II / III (T21-T24)
 SR20R IV (T21-T24)
 SR32J/JN (T21-T24)
 SW12RII (T21-T24)
 SV20R (T21-T24)
 ECAS12/20 (T21-T24)
 SW20 (T21-T23)

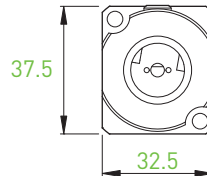
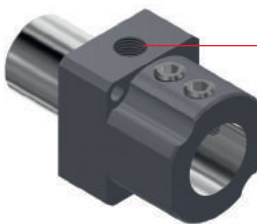

Art. N°

BWD1-2022-STAR-SW

Art. N°

BHS4-D20-55-BWD1
 BHS6-D20-55-BWD1

Types of STAR machines

SW12RII (T21-T28)
 SW20 (T21-T23 + T25-T27)
 SV20R (T21-T28)
 SR-20R IV (T21-T28)
 SB12/20R (T22-T24)
 SR38 (T21-T28)

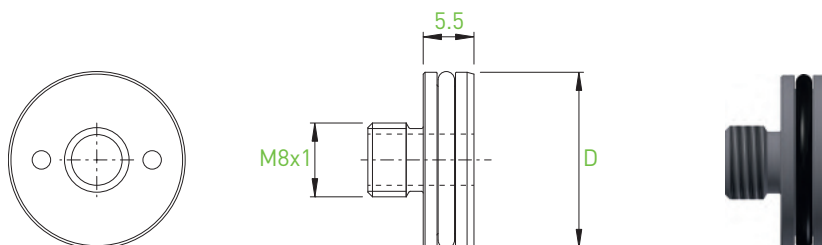

D	Art. N°	
19.05	JB-M8X1-D19.05	■
20	JB-M8X1-D20	■
22	JB-M8X1-D22	■
25	JB-M8X1-D25	■
25.4	JB-M8X1-D25.4	■